



BOSCH

ACCESSORIES PRICE LIST 2026

The best your tool can get. Bosch Professional Accessories.



*This Price List supercedes all previous editions. Prices and specifications are subject to change without notice.

ALWAYS THE RIGHT CHOICE

3 performance classes. No matter the challenge, no matter the expectation. Make the right choice.



Bosch EXPERT stands for top performance and advanced technologies reflecting our commitment to excellence and innovation. Our EXPERT accessories help you deal with the toughest materials and most demanding applications.

Bosch PRO brings in a comprehensive selection of accessories for every task. Each accessory within the PRO performance class is designed for efficiency in its own specific application and material, allowing you to take productivity to a higher level.

Bosch completes our portfolio and offers trusted-quality accessories the users worldwide have been relying on for decades. The accessories in this performance class are made to help you get the job done.

EXPERT

PRO



Learn more



EXPERT

Top Performance

PRO

Boosted Productivity

Trusted Quality

3 PERFORMANCE CLASSES

Our products are divided into 3 performance classes to guide you through our vast portfolio. The packaging colours and design make the performance class and key information about our accessories clear and easy to find

BENEFIT

The benefit icon shows the key benefit of the product – you can easily tell if the accessory is best for durability, speed, or precision



TECHNOLOGY BEHIND THE BENEFIT

Bosch Technology icons point out our most advanced technologies

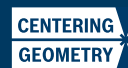

MATERIAL PICTURES

High-quality images show the material you can process with the accessory



* Bosch EXPERT or PRO products vs. Bosch standard products

Bosch Accessories guarantee your success

Bosch is the leading manufacturer of accessories for Power Tools. The rich tradition of manufacturing has been built on excellent quality and customer's benefit. Today, Bosch is the top supplier of an extensive and universal range of accessories for all applications, target groups and all brands of Power Tools. With more than 8000 products, Bosch offers everything from a single source - a complete range in outstanding product quality.



Innovation leader with over 130 years of tradition

Bosch is the leading name in the field of modern Power Tools with its cutting edge technologies for the past 130 years. Powered with its own research and development team, Bosch aims to develop innovative accessories for all applications to promote efficient working with reduced labour. Bosch has also registered several hundred patents with its innovative applications and has transformed the accessories sector with its brilliance. Experience the best. Always.



CONTENTS

01. DRILLING

SDS Plus Hammer Drill Bit	15
SDS Max Hammer Drill Bit	22
Masonry Drill Bit	28



02. CHISELLING

SDS Plus Chisels	33
SDS Max Chisels	34
Hex Chisels for 16 kg Hammer	34
Hex Chisels for 27 kg Hammer	34
Hex Chisels for 5 kg Hammer	34

03. DIAMOND CUTTING, GRINDING & DRILLING

Diamond Cutting Discs	37
Diamond Grinding Discs	37



04. CIRCULAR SAW BLADES

Eco Range	39
Expert Range	39

05. HOLESAW

Expert TCT Holesaws	49
Bi-Metal Holesaws	50
Hole Cutters & Holesaw Sets	51
Sheet Metal Holesaws	51

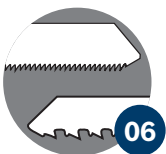
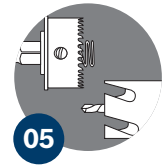

06. HACKSAW

Hacksaw Frame and Blade	53
-------------------------	----

07. JIGSAW BLADES

Wood	55
Wood + Metal	57
Metal	57
Special Material	60



08. SABRE SAW BLADES

Metal	64
Wood + Metal	65
Wood	66
Special Material	67

09. ROUTER BIT SETS

Routing	69
---------	----



10. PLANER KNIVES

Planer Knives	72
---------------	----

CONTENTS



11. COATED ABRASIVES

Colour Foam Abrasives	74
Hook and Loop (Velcro) Sanding Sheets	77
Flap Discs	78
Fibre Sanding Discs	78
Pressure Sensitive Adhesive Discs	79
Bosch Net	79
Backing Pads	80
Polishing Sponges	80
Foam Blocks & Foam Pads	80
Hand Sanding Sheets	80
New SIA Rolls	81
Narrow Belt	82

12. CUTTING AND GRINDING

X-Lock	83
Cutting Discs	84
Grinding Discs	85
Bench Grinding Wheel	86
Grinding Stone	86
Wire Cup Brush	86

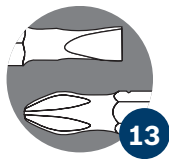
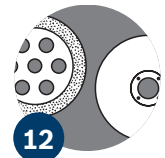

13. SCREWDRIVING BITS

Double Ended Bits	88
Impact Sockets	90
Nutsetters	92

14. WOOD DRILL BITS

Expert Spade Bit Sets	94
Expert Wood Bit Sets	94
Brad Point Bits	95
Spade Bits Eco - Clean Cut Range	95

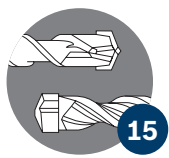

15. METAL DRILL BITS

Metal Drill Bits HSS PointTeQ	98
Metal Drill Bit Set - HSS-G	103
Metal Drill Bits - Cobalt Range	106
Metal Drill Bit Sets	107

16. MIXED SETS

Screwdriver Bits Sets	110
X Line drill and driver sets	116
Handtool Sets	117



17. STARLOCK

118

18. SYSTEM ACCESSORIES

Staples and Tacker	119
Accessories for GAC 250	120
Chucks	120
All other system accessories	120



LEADERS IN CREATING LEADERSHIP

A

Annular Cutter



B

Backing Pad,
Bench Grinding Wheel



C

Ceramic Disc, Concrete
Grinding Wheel, Cutting Wheel



H

Hacksaw, Hammer Drill Bits,
Hex Chisel, Holesaw, Hook & Loop

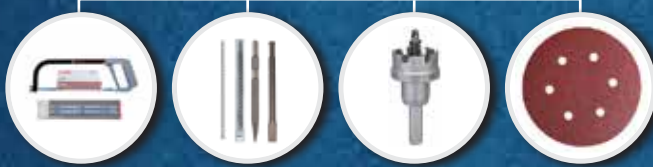

I

Impact Screwdriver Bits,
Inox Wheels



J

Jigsaw Blades



O

Oscillating
Accessories



P

Pick and Click,
PSA Disc



Pointte Q



R

Rolls, Router Bits



W

Wire Cup Brush, Wood Drill Bits



X

Lock Accessories



Bosch Universal

BONDED, BEYOND BONDED

Diamond
Blade



E-Wt Paper



Fibre Disc, Flap Disc,
Foam Pad



GAS 35 Dust Bag,
Grinding Wheel



Knives



Lambwool Bonnet



Metal Drill Bits,
Masonry Drill Bit



Net Abrasive,
Nutsetter



Sabre Saw Blade,
Screwdriver Bits



Tacker, TCT Blades



Universal
Holder



Vehicle Rescue Blade,
V Line Drill Bit Set



Yellow Sanding Sheet, CYL-2



Zirconia Range



Accessories

New Bosch PRO Packaging

PRO Range Overview



PRO Multimaterial Circular Saw Blade

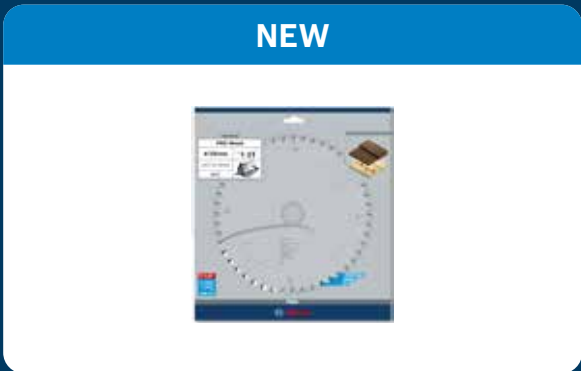

PRO Bonded Abrasives

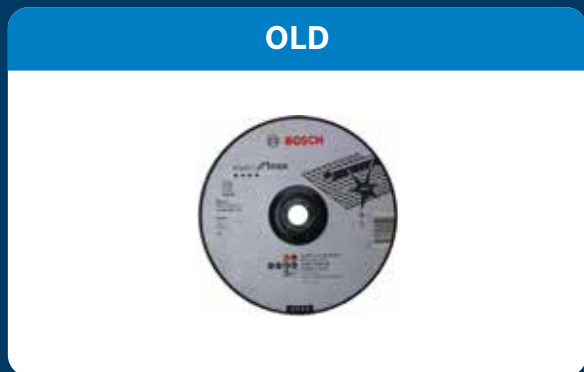
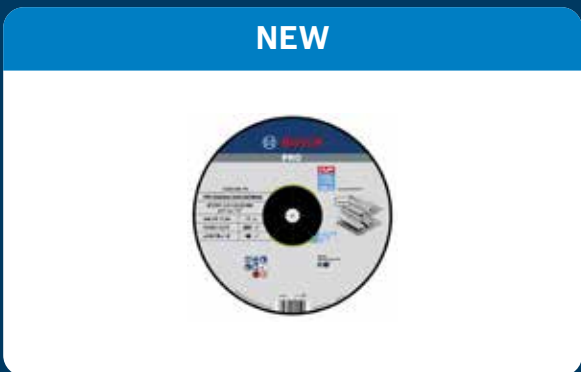

PRO Annular cutter





Verify the
Authenticity on
BeConnected
App

EVERY BUY EARNS
YOU REWARDS ON
BOSCH
ACCESSORIES



Now BeConnected on Accessories as well!

**Win assured Reward Points
on selected SKU's***

Contact local ASM for more details.

*For selected SKU's of 4" and 14" cutting wheel.

CUTS FAST, STAYS COOL.

CUTTING THE FINEST

NEW

7 INCH COOLTEQ



CIRCULAR SAW BLADES
Coolteq- 184 MM 16 Teeth

NEW!



Part Number	Outer Diameter mm	No. of Teeth	Kerf	Thickness mm	Bore Size mm	Thickness mm	Unit Pack Qty	List Price(₹)
H-Wood rough								
2608644717	184	16	1.6	1.1	25.4	1.1	1	350

NEW LAUNCH

4 INCH DIAMOND CUTTING WHEEL

CUTTING KA

CHAMPION



Key Features



Cuts Stone, Granite
and Marble



Built to German
Safety Standards



Affordable
Price

DIAMOND CUTTING DISCS
Expert for Universal

NEW!



Part Number	Dia meter mm	Segment Height mm	Unit Pack Qty	List Price(₹)
2608615280	105	7	1	100

ELEVATE YOUR GRINDING

WITH BOSCH 180 MM FLAP DISCS

Flap Discs 180 mm



Flap Disc 180mm

NEW!



Part Number	Disc Diameter mm	Grit	Unit Pack Qty	List Price(₹)
2608626199	180	36	5	100
2608626200	180	60	5	105
2608626201	180	80	5	100
2608626202	180	120	5	100

ELEVATE YOUR WORK WITH PICK & CLICK SETS



Standard Bit Handle



48x Extra Hard SD Bits



1x Standard Bit Hold

**50 Pcs Pick & Click
Sets/Display**



**50 Pcs Pick & Click
Sets/Display**

NEW!



Part Number	Description	Unit Pack Qty	List Price(₹)
2607012081	50 pcs Mixed Screwdriver bits set + additional screw handle 25 mm Screwdriver Bit: PH1 (2x); PH2 (4x); PH3 (2x); PZ1 (2x); PZ2 (4x); PZ3 (2x); T10; T15 (2x); T20 (3x); T25 (3x); T27; T30; T40; T10H; T15H; T20H (2x); T25H (2x); T27H; T30H; T40H; H3; H4 (2x); H5 (2x); H6; SL3; SL4; SL5 (2x); SL6, 55 mm Bit Holder: Standard Bit Holder Screwdriver Handle: 125 mm Screwdriver Handle.	1	1,550

CUT WITH CONFIDENCE. CRAFTED FOR PRECISION.



Fast & Secure Changes:

Quick accessory swaps for seamless workflow.



Precision Multi-Material Work:

Tackle diverse materials with accurate results.



Reliable Performance:

Consistent, high-quality output for every task.



Starlock

Oscillating Multi Tool



Part Number	Description	Diameter mm	Unit Pack Qty	List Price(₹)
2608669125	AVZ93 G	93	1	580
2608669086	ACZ85EIB	85	1	1,350
2608669120	ACZ85 RT3	85	1	1,950
2608669066	AIZ 32 APIB	50	1	1,023
2608669070	AIZ 32 BSPIB	50	1	750

LINE STIRRER BASKET

MIX SMARTER, NOT HARDER.



Can be disassembled into two parts.



Large mixing blades for optimum material flow.



M14 Outer Thread.

LINE Stirrer Basket



STIRRER BASKET 120 mm
Compatible with M14 Nut Size

NEW!



Part Number	Description	Dia meter mm	Length mm	Inter face	Mixing quantity	List Price(₹)
2608000842	Stirrer Basket 120 mm	120	600	M14(SW22)	15-25 Kg	1,060

NARROW BELT

POWERFUL, PRECISE, DURABLE PERFORMANCE



Premium Zirconia:
Balanced speed & lifetime.



Superior Joint:
Safe, smooth usage



Heavy-Duty Backing: High-quality X-wt
cloth for tough sanding.

Narrow Belt



NARROW BELT X540

NEW!



Part Number	Size	Grit	Unit Pack Qty	List Price(₹)
2608623389	50x2000 mm	36	15	2,625
2608623390	50x2000 mm	60	15	2,625
2608623391	50x2000 mm	80	15	2,625
2608623392	50x2000 mm	120	15	2,625

FASTER, DURABLE AND ECONOMICAL 3" AND 4" DIAMOND GRINDING WHEEL



Spacious Segments:
Faster work and better dust removal.



Balanced Design:
Low vibration for smoother, easier use.



EN Standard Certified:
Safe and reliable diamond tool.



Turbo Design:
Covers more area, lasts longer.



Balanced Design:
Low vibration for smoother, easier use.



EN Standard Certified:
Safe and reliable diamond tool.

Description	Dimensions	Part Number	Segment height	Best List Price/pc excl. GST
Bosch Diamond Cup Wheel turbo	80 x 16 mm	2608619961	4.5 mm	₹227
Bosch Diamond Cup Wheel segmented	80 x 16 mm	2608619962	4.5 mm	₹227
Bosch Diamond Cup Wheel turbo	100 x 16 mm	2608619963	5 mm	₹438
Bosch Diamond Cup Wheel segmented	100 x 16 mm	2608619964	5 mm	₹438

BOSCH 103 Pcs TITANIUM DRILLING AND SCREWDIVING BIT SET 2608594070



Part Number	Description	Unit Pack Qty	List Price(₹)
2608594070	Bosch 2608594070 Professional 103-Pcs Accessory Set Versatile Drilling & Screwdriving Kit Titanium-Coated Metal Drill Bits Precision Hole Saws for Clean Cutouts Durable & Organized Carry Case	1	2,649

1-pc Holesaw BiM Holesaw with in-built adaptor



**New
Launch!**

BIM HOLESAW WITH ADAPTOR

NEW!



Part Number	Diameter mm	List Price(₹)
2608644717	16	350
2609255600	19	323
2609255601	20	327
2609255602	22	347
2609255603	25	374
2609255604	29	429
2609255605	32	461
2609255606	35	495
2609255607	38	540
2609255608	44	544
2609255609	51	606

BIM HOLESAW WITH ADAPTOR

NEW!



Part Number	Diameter mm	List Price(₹)
2609255610	57	640
2609255611	60	660
2609255612	64	668
2609255613	65	702
2609255614	67	713
2609255615	68	717
2609255616	73	727
2609255617	76	744
2609255618	83	819
2609255619	95	881

ENGINEERED TO CUT DESIGNED TO LAST

Bosch Router Bits crafted for
clean and confident cuts.

AVAILABLE
IN SINGLE
BIT PACK

8mm

1/4"



2 608 628 394-879

Router bit		NEW!				
Part Number	Description	Shank mm	Unit Pack Qty	List Price (₹)		
2608629673	∅6.35xL20xS8	H-8 mm	1	550		
2608629674	∅12.7xL40xS8	H-8 mm	1	895		
2608629675	∅19xL25.4xS8	H-8 mm	1	830		
2608629676	∅12.7xL9.5xS8	H-8 mm	1	610		
2608629677	∅16xL25.4xS8	H-8 mm	1	790		
2608629681	R1.6x∅15.9xL7.9x∅S8	H-8 mm	1	550		
2608629678	∅14xL30xS8	H-8 mm	1	720		
2608629679	∅16xL30xS8	H-8 mm	1	790		
2608629680	90°x∅31.8xL20xS8	H-8 mm	1	799		
2608629692	∅1/2"xL1"xS1/4	H-1/4 inch	1	660		
2608629686	∅5/8"xL1"xS1/4	H-1/4 inch	1	790		
2608629690	R1/16"x∅5/8xL1/16"xS1/4	H-1/4 inch	1	550		
2608629691	R1/8"x∅3/4xL1/8xS1/4	H-1/4 inch	1	590		
2608629687	∅1-1/4"xL1/4"xS1/4	H-1/4 inch	1	770		
2608628405	R3.2x∅9.5xL10.2xS8	H-8 mm	1	400		
2608628356	R6.3x∅28.5xL13.2xS8	H-8 mm	1	670		
2608628358	R9.5x∅35xL16.2xS8	H-8 mm	1	790		
2608628393	R4.8x∅35xL14xS8	H-8 mm	1	790		
2608628394	R4x∅28.6xL12.4xS8	H-8 mm	1	670		
2608628395	R6.3x∅38.1xL17.1xS8	H-8 mm	1	850		
2608628396	R4.8x∅31.8xL14xS8	H-8 mm	1	890		
2608628397	R6.3x∅42.9xL17.7xS8	H-8 mm	1	950		
2608628398	R2.4x∅12.7xL12.4xS8	H-8 mm	1	450		
2608628357	R4.8x∅31.8xL12.4xS8	H-8 mm	1	750		
2608628359	R6.4x∅38xL15.7xS8	H-8 mm	1	890		
2608628420	R1/4"x∅1"xL1/2"xS1/4"	H-1/4 inch	1	550		
2608628424	R1/4"x∅1"xL35/64"xS1/4"	H-1/4 inch	1	600		
2608628352	45°x∅35xL14.7xS8	H-8 mm	1	670		
2608628367	R4x∅8xL9.2xS8	H-8 mm	1	420		
2608628368	R6x∅12xL9.2xS8	H-8 mm	1	450		
2608628369	R8x∅16xL12.4xS8	H-8 mm	1	480		
2608628346	∅9.5xL25.4xS8	H-8 mm	1	480		
2608628347	∅12.7xL13xS8	H-8 mm	1	510		
2608628348	∅12.7xL25.4xS8	H-8 mm	1	560		
2608628350	∅31.8xL12.5xS8	H-8 mm	1	690		
2608628339	R4x∅20.7xL10.2xS8	H-8 mm	1	650		
2608628340	R6x∅24.7xL13.2xS8	H-8 mm	1	650		
2608628341	R8x∅28.7xL15.2xS8	H-8 mm	1	650		

Router bit		NEW!				
Part Number	Description	Shank mm	Unit Pack Qty	List Price (₹)		
2608628342	R10x∅32.7xL16.2xS8	H-8 mm	1	750		
2608628343	R12x∅36.7xL18.6xS8	H-8 mm	1	790		
2608628344	R3x∅18.7xL10.2xS8	H-8 mm	1	590		
2608628402	∅32xL4xS8	H-8 mm	1	850		
2608628376	∅3xL8xS8	H-8 mm	1	300		
2608628377	∅4xL8xS8	H-8 mm	1	350		
2608628378	∅5xL12.7xS8	H-8 mm	1	350		
2608628379	∅6xL15.7xS8	H-8 mm	1	350		
2608628380	∅7xL19.6xS8	H-8 mm	1	400		
2608628381	∅8xL19.6xS8	H-8 mm	1	400		
2608628382	∅9xL19.6xS8	H-8 mm	1	400		
2608628383	∅10xL19.6xS8	H-8 mm	1	400		
2608628384	∅11xL19.6xS8	H-8 mm	1	490		
2608628385	∅12xL19.6xS8	H-8 mm	1	420		
2608628386	∅13xL19.6xS8	H-8 mm	1	430		
2608628375	∅14xL19.6xS8	H-8 mm	1	500		
2608628387	∅15xL19.6xS8	H-8 mm	1	450		
2608628388	∅16xL19.6xS8	H-8 mm	1	450		
2608628389	∅18xL24.6xS8	H-8 mm	1	470		
2608628390	∅20xL24.6xS8	H-8 mm	1	510		
2608628391	∅22xL24.6xS8	H-8 mm	1	550		
2608628392	∅25xL19.6xS8	H-8 mm	1	550		
2608628372	∅8xL25xS8	H-8 mm	1	390		
2608628373	∅10xL25xS8	H-8 mm	1	450		
2608628374	∅12xL31.5xS8	H-8 mm	1	460		
2608628406	60°x∅11xL13.7xS8	H-8 mm	1	360		
2608628407	90°x∅16xL15.7xS8	H-8 mm	1	380		
2608628416	45°x∅1 3/8"xL37/64"xS1/4"	H-1/4 inch	1	650		
2608628418	R1/4"x∅1/2"xL23/64"xS1/4"	H-1/4 inch	1	370		
2608628425	R1/8"x∅1/4"xL23/64"xS1/4"	H-1/4 inch	1	310		
2608628635	∅1/4"xL21/32"xS1/4"	H-1/4 inch	1	450		
2608628421	R1/4"x∅1"xL33/64"xS1/4"	H-1/4 inch	1	650		
2608628422	R3/8"x∅1 1/4"xL41/64"xS1/4"	H-1/4 inch	1	670		
2608628411	∅1/4"xL5/8"xS1/4"	H-1/4 inch	1	360		
2608628413	∅1/2"xL49/64"xS1/4"	H-1/4 inch	1	450		
2608628429	∅5/16"xL49/64"xS1/4"	H-1/4 inch	1	350		
2608628415	90°x∅1/2"xL31/64"xS1/4"	H-1/4 inch	1	350		

DRILLING

SDS Plus Hammer



SDS PLUS SHANK



	SDS PLUS-1	SDS PLUS-5X
		
Lifetime	•	••••
Speed	••	•••
Drilling dust removal	•••	••••
Tip	-	Centering tip Special cutting geometry for efficient dust removal and robust tip
Cutting edges	2-cutter	Carbide 4-cutter
Carbide	Standard carbide	Fine grade, highly durable carbide
Flute	2-flute U-shape	4-flute robust design



Low-cost drilling



Efficient drilling and resistant to rebar

•/•• = good

•••/•••• = better

••••• = best

SDS PLUS-1

Quality Hit, Budget Fit



x 30 =



SDS PLUS-1 - DRILL BIT SETS

Pack Quantity 30

NEW!



Part Number	Description	Pack Qty	List Price ₹
2608707302	Hammer drill bit SDS plus-1 6x50x110 mm	30	1,815
2608707303	Hammer drill bit SDS plus-1 6x100x160 mm	30	1,959
2608707304	Hammer drill bit SDS plus-1 8x50x110 mm	30	2,020
2608707305	Hammer drill bit SDS plus-1 8x100x160 mm	30	2,187
2608707306	Hammer drill bit SDS plus-1 10x100x160 mm	30	2,334
2608707307	Hammer drill bit SDS plus-1 10x150x210 mm	30	3,257
2608707308	Hammer drill bit SDS plus-1 12x100x160 mm	30	2,401
2608707309	Hammer drill bit SDS plus-1 12x150x210 mm	30	3,714

SDS PLUS-1

Quality Hit, Budget Fit

NEW!



x 11 =



NEW!

SDS PLUS-1 - DRILL BIT SETS
Pack Quantity 11

Part Number	Description	Unit Pack Qty	List Price(₹)
2608579911	6x50x110	11	811
2608579912	8x50x110	11	903
2608579708	6x100x160	11	866
2608579709	8x100x160	11	967
2608579710	10x100x160	11	1,033
2608579711	12x100x160	11	1,062

NEW!

SDS PLUS-1 - DRILL BIT SETS

Part Number	Description	Unit Pack Qty	List Price(₹)
2608579118	6x100x160, 8x100x160, 10x100x160	3	265
2608579119	5x50x110, 6x50x110, 6x100x160, 8x100x160, 10x100x160	5	418
2608579120	6x100x160, 6x100x160, 8x100x160, 10x100x160, 12x100x160	5	442
2608579121	5x50x110, 6.5x50x110, 8x50x110, 10x100x160, 12x100x160	5	452

SDS PLUS-1 Hammer Drill Bit



Part Number	Diameter mm	Working Length mm	Total Length mm	Unit Pack Qty	List Price(₹)
2608680257	4	50	110	1	97
2608680258	5	50	110	1	82
2608680259	5	100	160	1	109
2608680260	5.5	50	110	1	111
2608680261	5.5	100	160	1	108
2608680262	6	50	110	1	80
2608680263	6	100	160	1	87
2608680264	6	150	210	1	133
2608680265	6.5	50	110	1	102
2608680266	6.5	100	160	1	110
2608680267	7	50	110	1	109
2608680268	7	100	160	1	114
2608680269	8	50	110	1	89
2608680270	8	100	160	1	97
2608680271	8	150	210	1	145
2608680272	8	200	260	1	184
2608680273	10	100	160	1	103
2608680274	10	150	210	1	132
2608680275	10	200	260	1	182
2608680276	10	400	460	1	293
2608680277	12	100	160	1	106
2608680278	12	150	210	1	151
2608680279	12	200	260	1	205
2608680280	12	400	460	1	359
2608680281	14	100	160	1	174
2608680282	14	150	210	1	246
2608680283	14	200	260	1	277
2608680284	14	400	460	1	388
2608680285	16	150	210	1	253
2608680286	16	250	310	1	305
2608680287	16	400	460	1	526
2608680288	18	200	260	1	338
2608680289	18	400	460	1	566
2608680290	20	200	260	1	543

SDS PLUS-1 Hammer Drill Bit



Part Number	Diameter mm	Working Length mm	Total Length mm	Unit Pack Qty	List Price(₹)
2608680291	20	400	460	1	735
2608680292	22	200	260	1	592
2608680293	22	400	460	1	880
2608680294	25	200	260	1	665
2608680295	25	400	460	1	950

SDS PLUS-3 HAMMER DRILL BIT

Pack Quantity 10

*Available only till stock lasts.



Part Number	Diameter mm	Working Length mm	Unit Pack Qty	Unit List Price(₹)
2608830941	5	110	10	2,248
2608830942	5	160	10	2,678
2608830943	5.5	110	10	2,300
2608830944	5.5	100	10	2,960
2608830948	6.5	100	10	2,450
2608830950	6.5	200	10	3,575
2608830951	7	100	10	2,789
2608830955	8	150	10	3,508
2608830956	8	200	10	3,792
2608830957	10	50	10	2,490
2608830958	10	100	10	2,607
2608830962	12	200	10	4,317
2608830964	16	210	10	4,354
2608831160	4	160	1	406
2608831161	5	110	1	198
2608831162	5	160	1	259
2608831168	6	210	1	282
2608831169	6	260	1	300
2608831170	6.5	110	1	262
2608831171	6.5	160	1	281
2608831172	6.5	210	1	380
2608831173	6.5	260	1	386
2608831174	7	110	1	283
2608831175	7	160	1	353

SDS PLUS-3 HAMMER DRILL BIT

*Available only till stock lasts.



Part Number	Diameter mm	Working Length mm	Unit Pack Qty	List Price(₹)
2608831176	7	210	1	363
2608831180	8	260	1	360
2608831182	9	160	1	322
2608831188	10	360	1	783
2608831190	11	160	1	366
2608831197	14	160	1	495
2608831408	18	300	1	1,202
2608831410	18	450	1	1,679
2608831411	20	200	1	1,117
2608831413	20	350	1	1,602
2608831417	22	450	1	2,374

SDS-PLUS CHUCK AND ADAPTER



Part Number	Description	Unit Pack Qty	List Price(₹)
2607000982	Drilling Chucks	1	1,894

SDS PLUS-5X HAMMER DRILL BIT 4 Cutter, 4 Flute

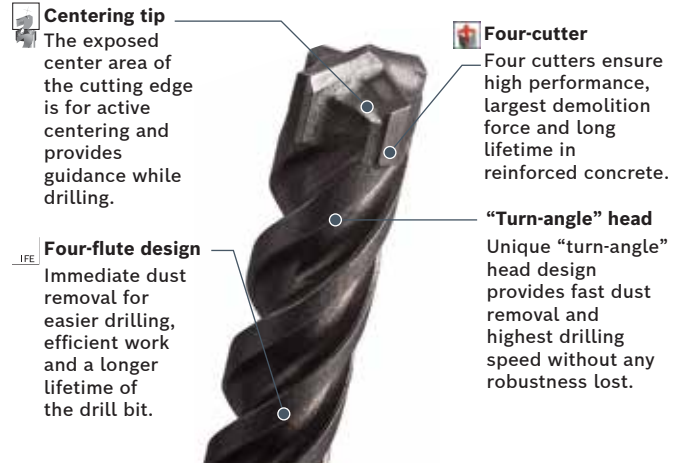

*For approximate total length of SDS plus bits add 60 mm to working length.



SDS PLUS-5X HAMMER DRILL BIT 4 Cutter, 4 Flute					
Part Number New! Part Number	Diameter mm	Working Length mm	Total Length mm	Unit Pack Qty	List Price (₹)
2608833771* New!2608706863	5	50	110	1	181
2608833772* New!2608706864	5	100	160	1	209
2608833773* New!2608706865	5	150	210	1	237
2608833774* New!2608706869	5.5	50	110	1	206
2608833775 New!2608706870	5.5	100	160	1	225
2608833776* New!2608706871	5.5	150	210	1	246
2608833777* New!2608706875	6	50	110	1	180
2608833778* New!2608706876	6	100	160	1	206
2608833779* New!2608706877	6	150	210	1	257
2608833780* New!2608706878	6	200	260	1	286
2608833781 New!2608706881	6.5	50	110	1	205
2608833782* New!2608706882	6.5	100	160	1	223
2608833783* New!2608706883	6.5	150	210	1	283
2608833784* New!2608706884	6.5	200	260	1	319
2608833785* New!2608706886	7	50	110	1	194
2608833786* New!2608706887	7	100	160	1	256
2608833787 New!2608706888	7	150	210	1	292
2608833788* New!2608706890	8	50	110	1	210
2608833789* New!2608706891	8	100	160	1	235
2608833790* New!2608706892	8	150	210	1	283
2608833791* New!2608706893	8	200	260	1	338
2608833792* New!2608706894	8	250	310	1	351
2608833793* New!2608706895	8	300	360	1	408
2608833794* New!2608706896	8	400	460	1	671
2608833795* New!2608706898	9	100	160	1	261
2608833796* New!2608706899	9	150	210	1	270
2608833797* New!2608706901	10	50	110	1	214
2608833798* New!2608706902	10	100	160	1	236
2608833799* New!2608706903	10	150	210	1	299
2608833800* New!2608706904	10	200	260	1	349

SDS PLUS-5X HAMMER DRILL BIT 4 Cutter, 4 Flute					
Part Number New! Part Number	Diameter mm	Working Length mm	Total Length mm	Unit Pack Qty	List Price (₹)
2608833801* New!2608706905	10	250	310	1	425
2608833802* New!2608706906	10	300	360	1	677
2608833803* New!2608706907	10	400	460	1	686
2608833804* New!2608706909	11	100	160	1	302
2608833805* New!2608706910	11	150	210	1	327
2608833806* New!2608706911	11	200	260	1	343
2608833807* New!2608706912	12	100	160	1	348
2608833808* New!2608706913	12	150	210	1	389
2608833809* New!2608706914	12	200	260	1	435
2608833810* New!2608706915	12	250	310	1	456
2608833811* New!2608706916	12	300	360	1	651
2608833812* New!2608706917	12	400	460	1	751
2608706920* New!2608833813	13	100	160	1	388
2608706921* New!2608833814	13	150	210	1	396
2608706922* New!2608833815	13	200	260	1	446
2608706923* New!2608833816	14	100	160	1	457
2608706924* New!2608833817	14	150	210	1	476
2608706925* New!2608833818	14	200	260	1	544
2608706926* New!2608833819	14	250	310	1	571
2608706927* New!2608833820	14	300	360	1	707
2608706928* New!2608833821	14	400	460	1	816
2608706931* New!2608833822	15	100	160	1	400
2608706932 New!2608833823	15	200	260	1	494
2608706933* New!2608833824	15	400	460	1	731
2608706934 New!2608833825	16	150	210	1	585
2608706935* New!2608833826	16	200	260	1	604
2608706936 New!2608833827	16	250	310	1	735
2608706937* New!2608833828	16	300	360	1	850
2608706938* New!2608833829	16	400	460	1	979
2608706943* New!2608836631	18	150	210	1	830

*New part number prices will be revised post clearance of old stock.

*For approximate total length of SDS plus bits add 60 mm to working length.

**SDS PLUS-5X HAMMER
DRILL BIT
4 Cutter, 4 Flute**

Part Number New! Part Number	Diameter mm	Working Length mm	Total Length mm	Unit Pack Qty	List Price (₹)
2608706944* New!2608836632	18	250	310	1	926
2608706950* New!2608836633	18	400	460	1	1,149
2608706950* New!2608836639	20	150	210	1	862
2608706951* New!2608836640	20	250	310	1	1,070
2608706952* New!2608836641	20	400	460	1	1,292
2608706954* New!2608836644	22	200	260	1	1,070
2608706955* New!2608836645	22	400	460	1	1,437
2608706957* New!2608836647	24	200	260	1	1,149
2608706958* New!2608836648	24	400	460	1	1,501
2608706961* New!2608836651	26	200	260	1	1,292
2608706962* New!2608836652	26	400	460	1	1,836

**SDS PLUS-9
REBAR CUTTER**

Part Number	Diameter mm	Working Length mm	Unit Pack Qty	List Price(₹)
2608586994	16	120	1	1,863
2608586995	18	120	1	2,793
2608586996	20	120	1	2,725
2608586997	22	120	1	3,092
2608586998	25	120	1	2,588
2608586999	28	120	1	3,815
2608587100	32	120	1	3,890

*New part number prices will be revised post clearance of old stock.



DRILLING

SDS Max Hammer



QUALITY HIT, BUDGET FIT

SDS Max-2

Good quality at an AFFORDABLE PRICE

NEW!

Centering tip

for a deep and stable
drill in at beginning
of the work

Standard **2-cutter design**,

durable carbide
for longer lifetime, best
performance in its class

SDS Max shank

for usage with all
SDS Max hammers

2-flute design

ensures smooth dust
removal for higher
drilling speed

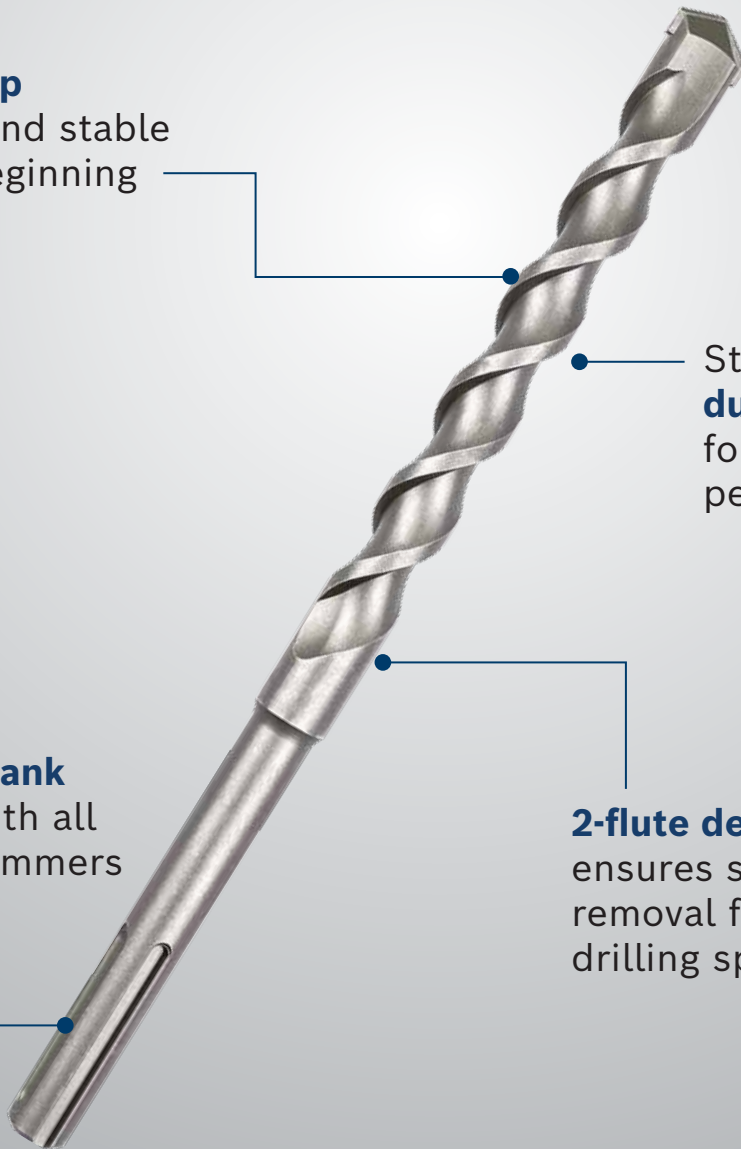

Full Range: 12 mm diameter to 40 mm diameter

**SDS MAX-2
Hammer Drill Bit**

Part Number	Diameter mm	Working Length mm	Total Length mm	Unit Pack Qty	List Price(₹)
2608578003	12	195	340	1	515
2608578005	14	195	340	1	593
2608578007	16	195	340	1	670
2608578762	16	395	540	1	934
2608578010	18	195	340	1	748
2608578013	18	395	540	1	934
2608578014	20	195	340	1	825
2608578017	20	395	540	1	980
2608578018	22	195	340	1	902
2608578021	22	395	540	1	1,057
2608578022	25	195	340	1	980
2608578025	25	395	540	1	1,147
2608578026	28	195	340	1	1,057
2608578029	28	395	540	1	1,708
2608578030	30	190	340	1	1,173
2608578032	30	390	540	1	1,870
2608578033	32	190	340	1	1,250
2608578035	32	390	540	1	2,024
2608578151	32	420	570	1	2,024
2608578152	32	740	920	1	2,334
2608578037	35	390	540	1	2,334
2608578763	38	190	340	1	2,024
2608578764	38	390	540	1	3,030
2608578039	40	390	540	1	2,798

**SDS MAX-7
Hammer Drill Bit**

*Available only till stock lasts.



Part Number	Diameter mm	Working Length mm	Total Length mm	Unit Pack Qty	List Price(₹)
2608586753	16	600	740		4,358
2608586755	16	1200	1320		11,609
2608586762	16	1200	1340		11,533
2608586756	17	200	340		2,701
2608586757	17	400	540		3,300
2608586759	18	200	200		2,781
2608586759	18	400	540		3,053
2608586760	18	600	720		4,233
2608586760	18	800	800		8,125
2608586764	19	400	520		5,095
2608586765	20	200	320		2,800
2608586766	20	400	520		3,045
2608586767	20	600	720		3,887
2608586768	20	800	920		5,764
2608586769	20	1200	1320		10,684
2608586770	22	200	320		3,024
2608586771	22	400	520		3,236
2608586771	22	800	800		7,428
2608586775	24	200	320		3,176
2608586776	24	400	520		2,675
2608586777	25	200	200		3,289
2608586778	25	400	400		3,749
2608586779	25	600	600		4,910
2608586780	25	800	920		9,122
2608586782	26	200	200	1	4,990
2608586783	26	400	400	1	4,140
2608586785	28	200	320	1	3,859
2608586786	28	400	520	1	4,432
2608586787	28	800	800	1	6,993
2608586788	28	1200	1320	1	15,203
2608586789	30	200	320	1	3,885
2608586790	30	400	520	1	4,622
2608586791	32	200	200	1	3,999
2608586792	32	400	400	1	5,160
2608586793	32	600	600	1	7,941
2608586794	32	800	920	1	9,476
2608586795	32	1200	1320	1	15,036

**SDS MAX-7
Hammer Drill Bit**

*Available only till stock lasts.



Part Number	Diameter mm	Working Length mm	Total Length mm	Unit Pack Qty	List Price(₹)
2608586738	12	200	340	-	1,970
2608586739	12	400	540	-	2,431
2608586740	12	600	740	-	4,496
2608586741	12	800	940	-	5,614
2608586744	14	200	200	1	2,399
2608586745	14	400	540	-	2,775
2608586746	14	600	740	-	5,061
2608586747	14	800	940	-	4,885
2608586751	16	200	340	-	2,567
2608586752	16	400	540	-	2,910

**SDS MAX-7
Hammer Drill Bit**

*Available only till stock lasts.



Part Number	Diameter mm	Working Length mm	Total Length mm	Unit Pack Qty	List Price(₹)
2608586796	35	400	520	1	6,041
2608586797	35	600	720	1	10,776
2608586800	38	400	520	1	7,045
2608586798	38	600	920	1	16,344
2608586801	38	600	720	1	12,451
2608586802	40	400	520	1	7,801
2608586803	40	600	720	1	12,204
2608586804	40	800	920	1	15,088
2608586805	40	1200	1320	1	15,372
2608586806	45	400	520	1	11,940
2608586807	52	400	520	1	13,486

**SDS MAX-9 NATURAL STONE
Hammer Drill Bit**

Part Number	Diameter mm	Working Length mm	Total Length mm	Unit Pack Qty	List Price(₹)
1618596502	28	400	520	1	6,879
1618596503	28	600	720	1	6,955
1618596504	28	800	920	1	11,519
1618596505	32	400	520	1	8,722
1618596506	32	600	720	1	8,470
1618596507	32	800	920	1	11,493



LONG LIFE DRILLING REINFORCED CONCRETE

EXPERT SDS max-8X
Concrete Drill Bits

**CARBIDE
TECHNOLOGY**

Exceptionally durable drill bit tip
with Bosch Carbide Technology

Punch through reinforced concrete
with a 4-cutter Full Carbide Head

Highly resistant drill tip connection
with Bosch Welding Technology

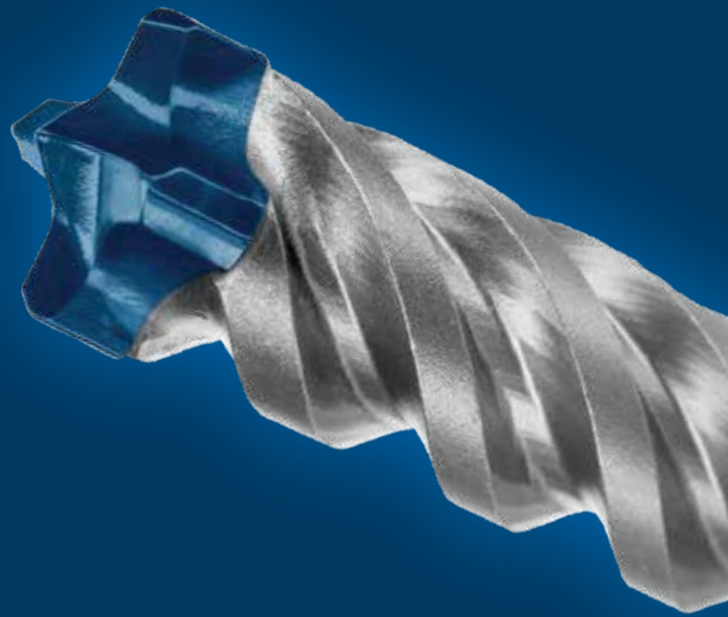

**SDS MAX-8X
Hammer Drill Bit**

*Available only till stock lasts.



OLD Part Number	Diameter mm	Working Length mm	Total Length mm	Pack Qty	List Price ₹
2608578604	12	600	740	1	3,849
2608578605	12	800	940	1	6,551
2608578607	14	400	540	1	3,309
2608578608	14	600	740	1	3,440
2608578609	14	800	940	1	7,206
2608578614	16	600	740	1	4,733
2608578615	16	800	940	1	7,255
2608578621	18	600	740	1	4,308
2608578622	18	800	940	1	6,846
2608578631	22	200	320	1	3,555
2608578634	22	800	920	1	7,190
2608578636	24	200	320	1	3,652
2608578637	24	400	520	1	4,062
2608578643	26	200	320	1	3,767
2608578644	26	400	520	1	4,619
2608578645	28	200	320	1	4,619
2608578650	30	200	320	1	4,487
2608578652	32	200	320	1	5,028
2608578653	32	400	520	1	5,978

**SDS MAX-8X
Hammer Drill Bit**
EXPERT

NEW EXPERT Part Number	Diameter mm	Working Length mm	Total Length mm	Unit Pack Qty	List Price(₹)
2608900201	12	200	340	1	2,551
2608900202	12	400	540	1	3,024
2608900203	12	600	740	1	4,160
2608900204	12	800	940	1	6,552
2608900207	14	200	340	1	2,850

**SDS MAX-8X
Hammer Drill Bit**
EXPERT

NEW EXPERT Part Number	Diameter mm	Working Length mm	Total Length mm	Unit Pack Qty	List Price(₹)
2608900208	14	400	540	1	3,434
2608900209	14	600	740	1	3,908
2608900210	14	800	940	1	7,181
2608900214	16	200	340	1	3,086
2608900215	16	400	540	1	3,622
2608900216	16	600	740	1	4,803
2608900217	16	800	940	1	7,229
2608900221	18	200	340	1	2,976
2608900222	18	400	540	1	3,560
2608900223	18	600	740	1	5,243
2608900224	18	800	940	1	5,243
2608900228	20	200	320	1	3,544
2608900229	20	400	520	1	3,795
2608900230	20	600	720	1	4,504
2608900231	20	800	920	1	6,631
2608900233	22	200	320	1	3,670
2608900234	22	400	520	1	3,779
2608900235	22	600	720	1	5,385
2608900236	22	800	920	1	7,166
2608900238	24	200	320	1	3,763
2608900239	24	400	520	1	4,158
2608900240	25	200	320	1	3,905
2608900241	25	400	520	1	4,945
2608900242	25	600	720	1	5,925
2608900243	25	800	920	1	8,613
2608900245	26	200	320	1	3,874
2608900246	26	400	520	1	4,693
2608900247	28	200	320	1	4,693
2608900248	28	400	520	1	5,637
2608900249	28	600	720	1	6,430
2608900250	28	800	920	1	7,622
2608900252	30	200	320	1	5,295
2608900253	30	400	520	1	6,051
2608900254	32	200	320	1	5,547
2608900255	32	400	520	1	6,430
2608900256	32	600	720	1	8,195
2608900257	32	800	920	1	9,329



DRILLING

Masonry Drill Bit



MASONRY DRILL BIT-CYL-1

Part Number	Diameter mm	Working Length mm	Total Length mm	Unit Pack Qty	List Price(₹)
2608590200	3	30	60	10	180
2608590202	4	40	75	10	232
2608590205	5	50	85	10	262
2608590208	6	60	100	10	303
2608590210	6.5	60	100	10	338
2608590212	8	80	120	5	216
2608590214	10	80	120	5	294
2608590217	12	85	150	5	560

MASONRY DRILL BIT SETS CYL-1 - For Masonry Brick applications only

Part Number	Diameter mm	Unit Pack Qty	List Price(₹)
1609200204	3, 5, 8	3	173

MASONRY DRILL BIT SETS CYL-1 - For Masonry Brick applications only

Part Number	Diameter mm	Unit Pack Qty	List Price(₹)
2608590090	4, 5, 6, 8, 10	5	208

MASONRY DRILL BIT - CYL-2

Part Number	Diameter mm	Working Length mm	Unit Pack Qty	List Price(₹)
2608578114	3	30	1	31
2608578115	4	40	1	34
2608578116	5	50	1	40
2608578117	5.5	50	1	43
2608578118	6	60	1	46
2608578119	6.5	60	1	47
2608578120	8	80	1	67
2608578159	9	80	1	83
2608578121	10	80	1	93
2608578122	12	90	1	124
2608578123	14	90	1	164
2608578160	16	90	1	197

MASONRY/IMPACT DRILL BIT CYL-2 SETS - For Masonry Brick + Light Concrete applications

Part Number	Diameter mm	Unit Pack Qty	List Price(₹)
2608578124	6, 8, 10	3	193
2608578155	4, 5, 6, 8, 10	5	255
2608578156	3, 4, 5, 6, 7, 8, 9, 10	8	413

MASONRY DRILL BIT-CYL-2

Part Number	Diameter mm	Working Length mm	Unit Pack Qty	List Price(₹)
2608579311	3	30	10	279
2608579312	5	50	10	359
2608579314	6	60	10	412

MASONRY DRILL BIT - For drilling in Masonry, Tiles, Thin Metal & Light Concrete

Part Number	Diameter mm	Working Length mm	Unit Pack Qty	List Price(₹)
2608680698	5	50	1	130
2608680792	6	60	1	135
2608680793	6.5	60	1	114
2608680795	8	80	1	152
2608680796	10	80	1	160



CHISELLING



THE NEW GENERATION OF SDS-PLUS CHISELS

Pointed chisel SDS-plus



- ▶ The new pointed chisel with twisted tip and self-sharpening function enables more efficient working and reduces jamming in concrete.

Flat chisel SDS-plus

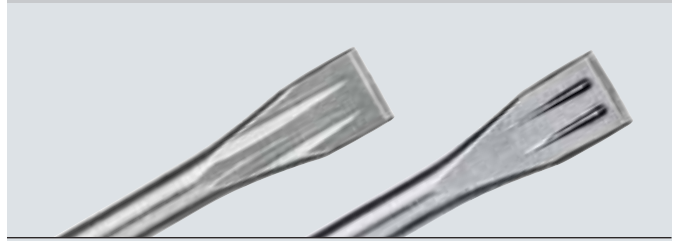

- ▶ Self-sharpening grooves on the front, which produce lateral and vertical cracks. These prevent jamming in concrete.
- ▶ Continuation of the successful "Viper Teeth" design on the back.

PROVEN SDS-MAX CHISELS

Pointed chisel SDS-max

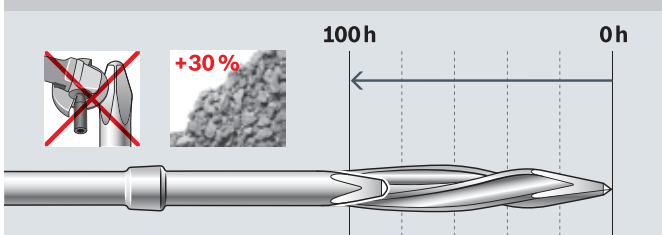

Increased power output

- ▶ No jamming
- ▶ Lifetime of 100 hours
- ▶ 30% higher material removal rate than standard pointed chisels

Flat chisel SDS-max

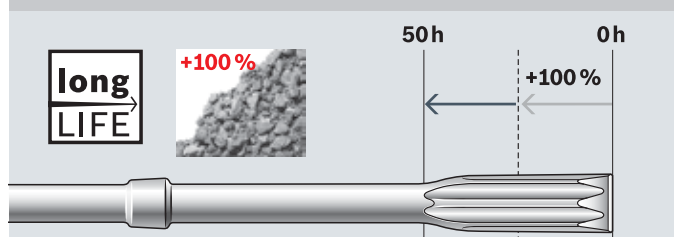

Double material removal rate

- ▶ 100% longer lifetime
- ▶ Self-sharpening cutting edge
- ▶ Double material removal rate

High blast power

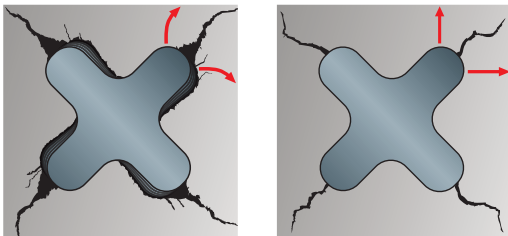

Greater material removal

Additional impact energy

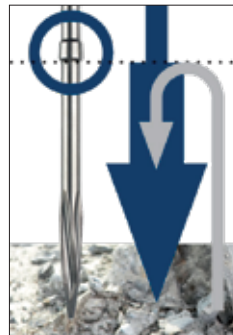

- ▶ The patented reflection element increases the power output: the recoil energy is converted into additional impact energy
- ▶ For an increase in material removal

As a provider of universal solutions, Bosch offers the self-sharpening function not only in existing SDS-max chisels, but also for selected chisels with the SDS plus shank system.

CHISEL WITH 22 MM HEX SHANK

Suitable for brand H-Hammers with “TE-S system”



CHISEL WITH 22 MM HEX SHANK					
Part Number	Total Length mm	Shape	Carton Box Qty	Unit Pack Qty	List Price(₹)
2608690188* New! 2608690620	400	Self-sharpening pointed	8	1	1,687
*Available till stocks last					

CHISEL WITH 22 MM HEX SHANK					
Part Number	Total Length mm	Shape	Carton Box Qty	Unit Pack Qty	List Price(₹)
2608690190 New! 2608690621	400	Self-sharpening flat	8	1	1,687

Eco SDS Plus Chisels

NEW!

- ▶ SDS plus pointed chisel without rotation stop for standard chiselling in concrete and brick
- ▶ SDS plus flat chisel provides standard chiselling for various renovation and restoration jobs



ECO SDS PLUS CHISELS				
Part Number	Total Length mm	Shape	Unit Pack Qty	List Price(₹)
2608578517	250	Pointed	10	1,654

ECO SDS PLUS CHISELS				
Part Number	Total Length mm	Shape	Unit Pack Qty	List Price(₹)
2608578519	250	Flat	10	1,654

CHISEL WITH 22 MM HEX SHANK



Part Number	Total Length mm	Shape	Unit Pack Qty	List Price(₹)
2608690188* New! 2608690620	400	Self-sharpening pointed	1	1,687
2608690190* New! 2608690621	400	Self-sharpening flat	1	1,687

CHISELS WITH SDS PLUS SHANK

Chisels for light rotary & demolition hammers



Part Number	Total Length mm	Shape	Unit Pack Qty	List Price(₹)
2608690091* New! 2608690572	260	Tile chisel, angled self-sharpening	1	1,848
1618600005* New! 2608690583	250	Pointed chisel	1	972
1618601004* New! 2608690578	250	Hollow gouging chisel	1	1,581
1618630888	-	Lawn neck tie tamping tool	1	12,612

ECO SDS PLUS CHISELS



Part Number	Total Length mm	Shape	Unit Pack Qty	List Price(₹)
2608578519	250	Flat chisel	10	1,654
2608578517	250	Pointed chisel	10	1,654

CHISELS WITH SDS MAX SHANK

Chisels for heavy rotary & demolition hammers



Part Number	Total Length mm	Shape	Unit Pack Qty	List Price(₹)
2608690061	400	RTEC chisel	1	1,065
2608690124* New! 2608690551	400	Flat chisel RTec Sharp	1	1,747
2608690166* New! 2608690575	400	Flat chisel RTec Sharp	10	11,802
2608690167* New! 2608690550	400	Pointed chisel RTec Speed	1	1,479
2608690168* New! 2608690561	400	Pointed chisel RTec Speed	10	14,622
1618600203* New! 2608690564	600	Flat chisel	1	1,869
1618601008* New! 2608690570	300	Spade chisel	1	2,665
1618601019	300	Tile chisel	1	3,507
1618601101	300	Hollow gouging chisel	1	2,282
1618601102	300	Gouging chisel	1	3,346
1618609003	220	Tool holder for tamping plates & bush hammer heads	1	2,934
1618633102	-	Tamping plate for max shank A	1	7,759

SDS MAX CHISELS



Part Number	Shape	Unit Pack Qty	List Price(₹)
2608690097* New! 2608690557	Wide chisel SDSMAX PRO L50 Lt350	1	1,943
1618600023* New! 2608690565	Pointed chisel SDSMAX 280 mm	1	3,376
1618601007* New! 2608690568	Wide chisel SDSMAX 350 x 115 mm	1	3,609
2608690125* New! 2608690563	Set 10 flat chisels SDSMAX 400 x 25 mm	1	3,587

CHISELS WITH SDS MAX



Part Number	Total Length mm	Shape	Unit Pack Qty	List Price(₹)
New! 2608690130	280	Pointed	10	3,587
New! 2608690127	280	Flat	10	3,587
2608690231	400	Pointed chisel	10	4,132
2608690232	600	Pointed chisel	10	5,110
2608690233	400	Flat chisel	10	4,132
2608690234	600	Flat chisel	10	5,110

CHISELS WITH SDS MAX SHANK TAMPING ADAPTER PRO



Part Number	Total Length mm	Shape	Unit Pack Qty	List Price(₹)
1618623205	60x60	Bush hammer head	1	3,778
1618623206	60x61	Bush hammer head	1	3,440

Chisels for Breakers

CHISELS WITH 28 MM HEX SHANK, HEX HPP, HEX MPP Suitable for 27 kg Hammer



Part Number	Total Length mm	Shape	Unit Pack Qty	List Price(₹)
2608690106* New! 2608690573	400	Pointed chisel, self-sharpening	1	2,706
1618600019* New! 2608690562	520	Pointed chisel	1	2,206
2608690108* New! 2608690582	400	Flat chisel	1	2,772
1618600206* New! 2608690567	520	Flat chisel	1	2,083
1618661000* New! 2608690584	400	Wide chisel	1	4,467

CHISELS WITH 30 MM HEX SHANK Suitable for 16 kg Hammer



Part Number	Total Length mm	Shape	Unit Pack Qty	List Price(₹)
2608690111* New! 2608690560	400	Pointed chisel, self-sharpening	1	3,052
2608690112* New! 2608690576	400	Flat chisel	1	3,153

*New part number prices will be revised post clearance of old stock.

CHISELS WITH 17 MM HEX SHANK (diameter 19 mm)
Suitable for 5 kg Hammer



Part Number	Total Length mm	Shape	Unit PackQty	List Price(₹)
2608690350	280	Pointed chisel	10	3,271
2608690351	280	Flat chisel	10	3,271
2608690382	450	Pointed chisel	5	2,361
2608690383	450	Flat chisel	5	2,361



DIAMOND CUTTING, GRINDING & DRILLING



NEW LAUNCH

4 INCH DIAMOND CUTTING WHEEL

CUTTING KA

CHAMPION



Key Features



Cuts Stone, Granite
and Marble



Built to German
Safety Standards



Affordable
Price

DIAMOND CUTTING DISCS
Expert for Universal

NEW!



Part Number	Dia meter mm	Segment Height mm	Unit Pack Qty	List Price(₹)
2608615280	105	7	1	100

BEST IN CLASS PRICE/ PERFORMANCE RATIO

Turbo Tile Cutting Blade
2608603615

Part Number	Diameter mm	Bore mm	Segment Height mm	Unit Pack Qty	List Price(₹)
2608603615	105	16/20	10	1	228

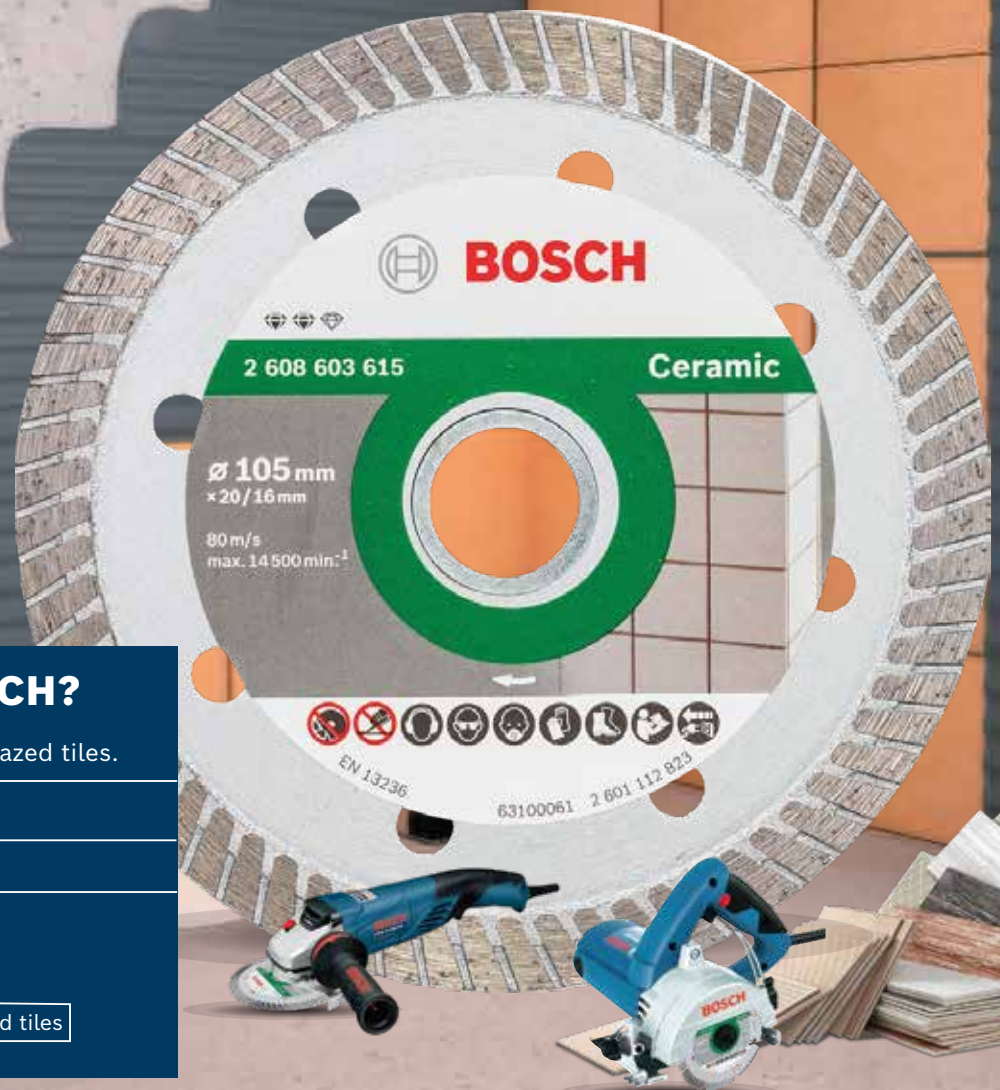

BENEFITS/WHY BOSCH?

- ▶ Can be used on both ceramic & glazed tiles.
- ▶ Zero chipping.
- ▶ Less material wastage.
- ▶ Good surface finish.

MATERIALS: Ceramic, Glazed tiles

DIAMOND CUTTING DISCS Expert for Universal				
Part Number	Diameter mm	Segment Height mm	Unit Pack Qty	List Price(₹)
New! 2608615280	105	7	1	100
New! 2608615232	110	10	1	115
2608602460	110	12	1	201

TURBO TILE CUTTING DISC 16/20 mm Bore					
Part Number	Diameter mm	Bore mm	Segment Height mm	Unit Pack Qty	List Price(₹)
2608603615	105	16/20	10	1	235

4" FULL RIM DIAMOND CUTTING BLADES For Tile Cutting					
Part Number	Diameter mm	Bore mm	Segment Height mm	Unit Pack Qty	List Price(₹)
2608602798	105	16/20	7	10	132
2608615050	110	16/20	10	1	148

4" DIAMOND CUTTING BLADE For Stone Cutting					
Part Number	Diameter mm	Bore mm	Segment Height mm	Unit Pack Qty	List Price(₹)
2608602464	110	16/20	12	1	203

DIAMOND CUTTING DISCS Expert for Universal 5" - 9" with 22.23 mm Bore				
Part Number	Diameter mm	Segment Height mm	Unit Pack Qty	List Price(₹)
2608615111	125	12	1	236
New! 2608615112*	150	12	1	266
2608615029				
2608615113	180	12	1	390
New! 2608615114*	230	12	1	618
2608615030				

DIAMOND CUTTING DISCS Standard for Concrete with 25 mm Bore				
Part Number	Diameter mm	Segment Height mm	Unit Pack Qty	List Price(₹)
2608602543	300	10	1	4,434
2608602544	350	10	1	5,449
2608602545	400	10	1	9,455
2608602546	450	10	1	11,041

DIAMOND CORE CUTTING BITS			
Part Number	Description	Unit Pack Qty	List Price(₹)
2608601733	28x300mm, G 1/2"	1	5,060
2608601734	32x300mm, G 1/2"	1	5,076
2608601735	42x400mm, G 1/2"	1	5,439
2608601736	52x450mm, 1 1/4"	1	3,769
2608601737	62x450mm, 1 1/4"	1	4,626
2608601738	72x450mm, 1 1/4"	1	3,902
2608601739	82x450mm, 1 1/4"	1	5,493
2608601740	102x450mm, 1 1/4"	1	6,071
2608601741	122x450mm, 1 1/4"	1	6,620
2608601742	132x450mm, 1 1/4"	1	7,723
2608601743	152x450mm, 1 1/4"	1	9,974
2608601744	202x450mm, 1 1/4"	1	13,337
2608601366	102x450mm, G 1 1/4"	1	10,754



DIAMOND CUP WHEEL
 Expert for Universal Turbo

NEW!



Part Number	Design	Diameter mm	Segment Height mm	Unit Pack Qty	List Price(₹)
2608603606	Segmented	100	2.5	1	709
2608619961	Turbo	80	4.5	1	240
2608619962	Segmented	80	4.5	1	240
2608619963	Turbo	100	5	1	463
2608619964	Segmented	100	5	1	463

ECO RANGE 5" CONCRETE GRINDING WHEELS

NEW!



Part Number	Diameter mm	Segment Height mm	No. of Segment	Pack Qty	List Price ₹
2608601778	100	2.5	-	1	781
2608601762	125	5	18	1	1,510
2608601763	125	5	9	1	1,431

DIAMOND GRINDING DISC
 Expert for Concrete

Part Number	Diameter mm	Segment Height mm	Unit Pack Qty	List Price(₹)
2608602552	125	4.5	1	5,684

SUCTION HOOD FOR CONNECTING VACUUM CLEANERS TO 5" ANGLE GRINDERS

NEW!



Part Number	Diameter mm	Unit Pack Qty	List Price(₹)
2608000882	125	1	930

7" CONCRETE GRINDING WHEEL

NEW!



Part Number	Diameter mm	Bore Size mm	Segment Height mm	Unit Pack Qty	List Price(₹)
2608601575	180	22.23	5	1	3,244

ECO RANGE 3", 4" AND 5" Concrete Grinding solution



₹781

2608601778



₹1,431

2608601763



₹1,510

2608601762



₹240

2608619961



₹240

2608619962



₹463

2608619963



₹463

2608619964

M14 bore

High removal rate

High lifetime

Part Number	Diameter mm	To be fitted in	Segment Height mm	No. of Segment	Unit Pack Qty	List Price(₹)
2608619961	80	4" grinder	4.5	-	1	240
2608619962	80	4" grinder	4.5	-	1	240
2608619963	100	4" grinder	5	-	1	463
2608619964	100	4" grinder	5	-	1	463
2608601778	100	5" grinder	2.5	-	1	781
2608601763	125	5" grinder	5	9	1	1,431
2608601762	125	5" grinder	5	18	1	1,510

CIRCULAR SAW BLADES



CSB ECO LINE 4" 30T & 40T

Upto 50% more Lifetime

▶ 2608839389 4" 30T

▶ 2608839390 4" 40T



Attractive Packaging

Fast cut

Clean cut

Cooling holes and expansion slots

Long lifetime



NEW!

CSB ECO LINE 4" 30T & 40T					
Part Number	Diameter mm	Teeth	Bore Size mm	Unit Pack Qty	List Price(₹)
2608839389	110	30	20	1	214
2608839390	110	40	20	1	252

Eco 6" Circular Saw Blade with 36 Teeth

NEW!



Main user benefit:

Affordable blades with fast and smooth cut, providing a superior lifetime with respect to competitors.

Part Number	Diameter mm	Teeth	Bore Size mm	Application	Unit Pack Qty	List Price(₹)
2608644371	150	36	20	Wood	1	651

7" CIRCULAR SAW BLADE WITH 24 TEETH

BENEFITS:

- ▶ ATB teeth type, 3-grinded edges for clean finishing.
- ▶ Thicker steel body for stable and smooth cutting, bigger teeth for less wear out and long lifetime.

NEW!



Part Number	Diameter mm	Number of Teeth	Kerf	Thickness mm	Bore size mm	Application	Unit Pack Qty	List Price(₹)
2608644303	180	24	1.6	1.1	25.4	Wood	1	406

CUTS FAST, STAYS COOL.

CUTTING THE FINEST

NEW

7 INCH COOLTEQ



CIRCULAR SAW BLADES Coolteq- 184 MM 16 Teeth

NEW!



Part Number	Outer Diameter mm	No. of Teeth	Kerf	Thickness mm	Bore Size mm	Thickness mm	Unit Pack Qty	List Price(₹)
H-Wood fine								
2608644717	184	16	1.6	1.1	25.4	1.1	1	350

CIRCULAR SAW BLADES
 Eco for Wood, Aluminium & Multi Material

Part Number	Outer Diameter mm	Number of Teeth	Kerf	Thickness mm	Bore Size mm	Reduction Ring	Unit Pack Qty	List Price(₹)
Wood								
2608644272	110	30	1.8	1.1	20.0	-	1	236
2608644273	125	30	1.8	1.1	20.0	-	1	252
2608644274	110	40	1.8	1.1	20.0	-	1	279
2608644275	125	40	1.8	1.1	20.0	-	1	305
2608644278	180	40	2.6	1.6	25.4	20	1	562
2608644279	180	60	2.6	1.6	25.4	20	1	648
2608644280	200	40	2.6	1.6	30.0	20	1	646
2608644281	200	60	2.6	1.6	30.0	20	1	761
2608644293	300	80	3.2	2.2	30.0	25.4	1	2,225
Aluminium								
2608644294	250	100	3	2.2	25.4	20	1	1,911
2608644295	300	120	3	2.2	30.0	20	1	2,796
Multi Material								
2608644276	110	40	1.8	1.1	20.0	-	1	299
2608644277	125	40	1.8	1.1	20.0	-	1	324

CIRCULAR SAW BLADES
 CoolteQ - 12 Teeth CSB - 10X Life with Fast Cut

NEW!



Part Number	Outer Diameter mm	Number of Teeth	Kerf	Thickness mm	Bore size mm	Unit Pack Qty	List Price(₹)
Wood							
2608644669	110	12	1.6	1	20.0	1	157
2608644670	125	12	1.6	1	20.0	1	172

CIRCULAR SAW BLADES
 CoolteQ- 16 Teeth CSB - 10X Life With Fast Cut

NEW!



Part Number	Outer Diameter mm	No. of Teeth	Kerf	Thickness mm	Bore Size mm	Thickness mm	Unit Pack Qty	List Price(₹)
H-Wood fine								
2608644717	184	16	1.6	1.1	25.4	1.1	1	350

CIRCULAR SAW BLADES
 Eco Upgrade for Wood: 4" with 30T & 40T

NEW!



Part Number	Outer Diameter mm	Number of Teeth	Kerf	Thickness mm	Bore size mm	Unit Pack Qty	List Price(₹)
Wood							
2608839389	110	30	1.6	1.1	20	1	220
2608839390	110	40	1.6	1.1	20	1	260
2608644272	110	30	1.6	1.1	20	1	236
2608644274	110	40	1.6	1.1	20	1	279

CIRCULAR SAW BLADES
 Eco for Wood: 7" with 24T

NEW!



Part Number	Outer Diameter mm	Number of Teeth	Kerf	Thickness mm	Bore size mm	Unit Pack Qty	List Price(₹)
Wood							
2608644303	180	24	2.2	1.4	25.4	1	406

CIRCULAR SAW BLADES
 Eco for Wood: 6" with 36T

NEW!



Part Number	Outer Diameter mm	Number of Teeth	Kerf	Thickness mm	Bore size mm	Unit Pack Qty	List Price(₹)
-------------	-------------------	-----------------	------	--------------	--------------	---------------	---------------

Wood

2608644371	150	36	2.2	1.4	20	1	651
------------	-----	----	-----	-----	----	---	-----

CIRCULAR SAW BLADES
 Eco Upgrade for Wood: 5" with 30T & 40T

NEW!



Part Number	Outer Diameter mm	Number of Teeth	Kerf	Thickness mm	Bore size mm	Unit Pack Qty	List Price(₹)
-------------	-------------------	-----------------	------	--------------	--------------	---------------	---------------

Wood

2608644273	125	30	1.6	1.1	20	1	252
2608644275	125	40	1.6	1.1	20	1	305

CIRCULAR SAW BLADES
 Expert Series - 184 mm

Part Number	Outer Diameter mm	No. of Teeth	Kerf	Thickness mm	Bore Size mm	Reduction Ring	Unit Pack Qty	List Price(₹)
-------------	-------------------	--------------	------	--------------	--------------	----------------	---------------	---------------

Wood

2608642977	184	16	2	1.4	20.0	16/5/8"	1	577
2608642979	184	24	2	1.4	20.0	16/5/8"	1	627
2608642980	184	40	2	1.4	20.0	16/5/8"	1	735
2608642981	184	60	2	1.4	20.0	16/5/8"	1	881
2608642982	184	24	2	1.4	25.4	20/19/16/5/8"	1	575
2608642984	184	40	2	1.4	25.4	20/19/16/5/8"	1	707
2608642985	184	60	2	1.4	25.4	20/19/16/5/8"	1	860

Multi Material

2608642193	184	60	2	1.5	20.0	16/5/8"	1	1,134
2608642194	184	60	2	1.5	25.4	16/19/20/5/8"	1	1,137

Speed for wood

2608643047	184	20	2	1.4	20.0	16/5/8"	1	754
2608643048	184	40	2	1.4	20.0	16/5/8"	1	963

CIRCULAR SAW BLADES
 Expert Series - 235 mm

Part Number	Outer Diameter mm	No. of Teeth	Kerf	Thickness mm	Bore Size mm	Reduction Ring	Unit Pack Qty	List Price(₹)
-------------	-------------------	--------------	------	--------------	--------------	----------------	---------------	---------------

Wood

2608642998	235	60	2.2	1.5	25.0	20/16/5/8"	1	1,303
------------	-----	----	-----	-----	------	------------	---	-------

Multi Material

2608642197	235	80	2	1.5	25.0	16/20/5/8"	1	1,329
------------	-----	----	---	-----	------	------------	---	-------

CIRCULAR SAW BLADES
 Expert Series - 254 mm For Mitre saws and Table saws

Part Number	Outer Diameter mm	No. of Teeth	Kerf	Thickness mm	Bore Size mm	Reduction Ring	Unit Pack Qty	List Price(₹)
Wood								
2608644341	254	32	—	—	30.0	—	1	2,843
2608643007	254	40	2.5	1.8	30.0	1"/25	1	1,149
2608643008	254	60	2.5	1.8	30.0	1"/25	1	1,404
2608643010	254	100	2.5	1.8	30.0	1"/25	1	1,890
Multi Material								
2608642198	254	100	2.7	2	25.4	16/20/5/8"	1	1,836
2608642199	254	120	2.7	2	25.4	16/20/5/8"	1	2,143
2608642202	254	100	2.7	2	30.0	25/1"	1	1,836
2608642203	254	120	2.7	2	30.0	25/1"	1	2,143

CIRCULAR SAW BLADES
 Expert Series - 305 mm For Mitre saws and Table saws

Part Number	Outer Diameter mm	No. of Teeth	Kerf	Thickness mm	Bore Size mm	Reduction Ring	Unit Pack Qty	List Price(₹)
Wood								
2608643021	305	40	2.5	1.8	25.4	20/16/ 5/8	1	1,563
2608643024	305	40	2.5	1.8	30.0	1"/25/20	1	1,563
2608643025	305	60	2.5	1.8	30.0	1"/25/20	1	1,845
2608643026	305	80	2.5	1.8	30.0	1"/25/20	1	2,237
2608643027	305	100	2.5	1.8	30.0	1"/25/20	1	2,615
2608643028	305	120	2.5	1.8	30.0	1"/25/20	1	3,070
Multi Material								
2608640982	305	80	2.7	2.0	30.0	-	1	2,162
2608642206	305	100	2.7	2.0	25.4	16/20/ 5/8"	1	2,975
2608642207	305	120	2.7	2.0	25.4	16/20/ 5/8"	1	3,119
2608642209	305	100	2.7	2.0	30.0	20/25/ 1"	1	2,975
2608642210	305	120	2.7	2.0	30.0	20/25/ 1"	1	3,119

CIRCULAR SAW BLADES
 Expert Series - 355 mm For Mitre saws and Table saws

Part Number	Outer Diameter mm	No. of Teeth	Kerf	Thickness mm	Bore Size mm	Reduction Ring	Unit Pack Qty	List Price(₹)
Multi Material								
2608642211	355	80	3	2.4	25.4	16/20/ 5/8"	1	3,257
2608642213	355	100	3	2.4	30.0	20/25/ 1"	1	4,036
2608642214	355	120	3	2.4	30.0	20/25/ 1"	1	4,149

CIRCULAR SAW BLADES
 Reducing Ring H

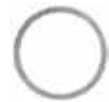
NEW!

Part Number	Diameter mm	Kerf	Thickness mm	Bore Size mm	Unit Pack Qty	List Price(₹)
2600100222	30	-	1.5	25	1	54

HOLESAWING



7 pcs HOLE CUTTER SET

- Aluminum plate holding the Holesaw: Sturdier
- Cutting depth-18 mm
- Used to drill holes in wood

₹535

New!

2609255635

1-pc Holesaw BiM Holesaw with in-built adaptor



BIM HOLESAW WITH ADAPTOR

NEW!



Part Number	Diameter mm	List Price(₹)
2609255600	19	323
2609255601	20	327
2609255602	22	347
2609255603	25	374
2609255604	29	429
2609255605	32	461
2609255606	35	495
2609255607	38	540
2609255608	44	544
2609255609	51	606

BIM HOLESAW WITH ADAPTOR

NEW!



Part Number	Diameter mm	List Price(₹)
2609255610	57	640
2609255611	60	660
2609255612	64	668
2609255613	65	702
2609255614	67	713
2609255615	68	717
2609255616	73	727
2609255617	76	744
2609255618	83	819
2609255619	95	881

EXPERT TCT HOLESAW

*Available only till stock lasts.



OLD Part Number	Diameter mm	Unit Pack Qty	List Price(₹)
2608594003	14	1	1,121
2608594004	15	1	1,121
2608594010	21	1	1,303
2608594014	25	1	1,336
2608594015	26	1	1,369
2608594016	27	1	1,369
2608594017	28	1	1,369
2608594018	29	1	1,436
2608594019	30	1	1,369
2608594020	31	1	1,572
2608594022	33	1	1,572
2608594023	34	1	1,572
2608594026	37	1	1,685
2608594033	44	1	1,807
2608594043	54	1	2,286
2608594049	70	1	2,831
2608594050	75	1	3,021
2608594051	80	1	3,192
2608594052	85	1	3,396
2608594053	90	1	3,588
2608594054	95	1	3,588
2608594055	100	1	3,982
2608594056	110	1	4,400
2608594057	120	1	4,788

TCT HOLESAW**EXPERT**

NEW EXPERT Part Number	Diameter mm	Unit Pack Qty	List Price(₹)
2608901397	14	1	1,121
2608901398	15	1	1,121
2608901399	16	1	1,169
2608901400	17	1	1,121
2608901401	18	1	1,121
2608901402	19	1	1,114
2608901403	20	1	1,121
2608901404	21	1	1,303
2608901405	22	1	1,330
2608901406	23	1	1,303
2608901407	24	1	1,303
2608901408	25	1	1,336
2608901409	26	1	1,369
2608901410	27	1	1,369
2608901411	28	1	1,369
2608901412	29	1	1,436
2608901413	30	1	1,369
2608901414	31	1	1,572

EXPERT TCT HOLESAW**EXPERT**

NEW EXPERT Part Number	Diameter mm	Unit Pack Qty	List Price(₹)
2608901415	32	1	1,623
2608901416	33	1	1,623
2608901417	34	1	1,623
2608901418	35	1	1,604
2608901419	36	1	1,685
2608901420	37	1	1,685
2608901421	38	1	1,658
2608901422	39	1	1,685
2608901423	40	1	1,719
2608901424	41	1	1,771
2608901425	42	1	1,771
2608901427	44	1	1,807
2608901428	45	1	1,771
2608901431	48	1	2,030
2608901432	49	1	2,030
2608901433	50	1	2,030
2608901434	51	1	2,333
2608901435	52	1	2,286
2608901437	54	1	2,286
2608901438	55	1	2,286
2608901439	60	1	2,423
2608901440	61	1	2,619
2608901441	62	1	2,619
2608901442	65	1	2,673
2608901443	70	1	2,831
2608901444	75	1	3,021
2608901445	80	1	3,193
2608901446	85	1	3,396
2608901447	90	1	3,588
2608901448	95	1	3,588
2608901449	100	1	3,982
2608901450	110	1	4,400
2608901451	120	1	4,788
2608901452	Pilot drill	1	358
2608901453	Spring	1	72
2608901454	Screw	1	102

**HSS BI-METAL HOLESAWS
FOR STANDARD ADAPTERS**

Part Number	Diameter mm	Unit Pack Qty	List Price(₹)
2608580396	14	1	254
2608580397	16	1	212
2608580398	17	1	230
2608580399	19	1	222
2608580401	21	1	220
2608580402	22	1	245
2608580404	25	1	269
2608580405	27	1	277
2608580406	29	1	316
2608580407	30	1	371
2608580408	32	1	336
2608580410	35	1	366
2608580411	37	1	380
2608580412	38	1	387
2608580413	40	1	387
2608580414	41	1	400
2608580416	44	1	439
2608580418	48	1	494
2608580419	51	1	535
2608580420	52	1	535
2608580421	54	1	545
2608580423	57	1	583
2608580425	60	1	606
2608580426	64	1	617
2608580427	65	1	631
2608580428	67	1	677
2608580430	70	1	694
2608580431	73	1	766
2608580432	76	1	823
2608580433	79	1	864
2608580434	83	1	902
2608580435	86	1	940
2608580436	89	1	890
2608580437	92	1	1,117
2608580438	95	1	1,028
2608580439	98	1	993
2608580440	102	1	1031
2608580444	114	1	1,232
2608580445	121	1	1,521

**HSS BI-METAL HOLESAWS
FOR STANDARD ADAPTERS**

Part Number	Diameter mm	Unit Pack Qty	List Price(₹)
2608580446	127	1	1,391
2608580448	152	1	1,706

**HSS BI-METAL HOLESAWS
FOR STANDARD ADAPTERS**
**LONG
LIFE!**

Part Number	Diameter mm	Unit Pack Qty	List Price(₹)
2608584102	20	1	523
2608584104	22	1	421
2608584107	29	1	490
2608584114	44	1	547
2608584115	46	1	552
2608584119	57	1	668

*Available till stocks last

**ACCESSORIES FOR
STANDARD BI-METAL
HOLESAWS**



Part Number	Description	Unit Pack Qty	List Price(₹)
2608596295	HSS-G Pilot drill bit separate for 14mm-30mm holesaw	1	215
2608596119	HSS-G Pilot drill bit separate for 32mm-210mm holesaw	1	274
2609390588	Hex adapter with 1/2"-20UNF thread and HSS-G pilot drill bit (2 608 596 295) Width across flats 9.52 mm. From diameter 14 mm/9/16" to diameter 30 mm/1 3/16"	1	410
2609390034	Hexagon adapter with 5/8"-18UNF thread and HSS-G pilot drill bit (2 608 596 119) Width across flats 11 mm. From 32 mm/1 1/4" to diameter 210 mm/8 9/32"	1	934
2609390036	SDS-plus adapter with 5/8" 18UNF thread and HSS-G pilot drill bit (2 608 596 295) From 32mm/1 1/4" to 210mm/8 9/32" Holesaw	1	1,563

HOLE CUTTERS

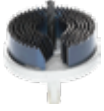

Part Number	Description	Unit Pack Qty	List Price(₹)
-------------	-------------	---------------	---------------

2609255635 **New!** 7 Prices set 1 534



2607019450 11 Prices set 1 825



HOLESAW SETS



Part Number	Description	Unit Pack Qty	List Price(₹)
-------------	-------------	---------------	---------------

2608580803 Plumber set, 9pcs, 6HS,
2 hex socket adapter,
1 hex nutsetter
- BiM - Standard HS
Ecoline Set
19/22/29/38/44/57 1 3,072

2608580804 Electrician set, 9pcs, 6HS,
2 hex socket adapter,
1 hex nutsetter
- BiM - Standard HS
Ecoline Set
20/25/32/38/51/64 1 3,440

2608580862 Universal set, 9pcs, 6HS,
2 hex socket adapter,
1 hex nutsetter
- BiM - Standard HS
Ecoline Set
24/27/32/35/40/52 1 3,072

2608580868 Electrician set, 9pcs, 6HS,
2 hex socket adapter,
1 hex nutsetter
- BiM - Standard HS
Ecoline Set
20/25/35/40/51/68 1 3,089

2608580866 Universal set, 12pcs, 9HS, 1
1 hex socket adapter,
1 305mm extension,
1 hex nutsetter
- BiM - Standard HS
Ecoline Set
35/54/70/76/83/95/102/1
14/127 1 9,215

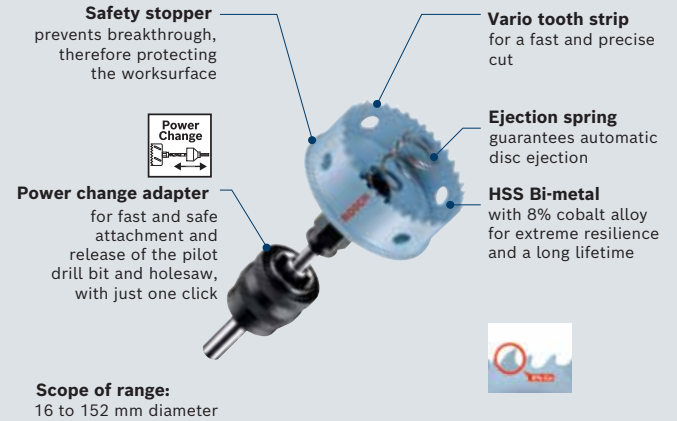
SPECIAL FOR SHEET METAL
The faster holesaw in metalSPECIAL FOR SHEET
METAL HOLESAWS

Part Number	Diameter mm	Length mm	Unit Pack Qty	List Price(₹)
2608584778* New! 2608594437	16	20	1	627/ 280
2608584780* New! 2608594439	19	20	1	523/ 290
2608584783* New! 2608594442	22	20	1	538/ 270
2608584784* New! 2608594443	25	20	1	557/ 320
2608584786* New! 2608594445	29	20	1	619/ 350
2608584787* New! 2608594446	30	20	1	675/ 370
2608584788* New! 2608594447	32	20	1	634/ 380
2608584790* New! 2608594449	35	20	1	690/ 390
2608584791* New! 2608594450	38	20	1	731/ 410
2608584792* New! 2608594451	40	20	1	843/ 420
2608584793* New! 2608594452	41	20	1	766/ 450
2608584794* New! 2608594453	44	20	1	795/ 490
2608584795* New! 2608594454	48	20	1	750/ 520
2608584796* New! 2608594455	51	20	1	873/ 540

**SPECIAL FOR SHEET
METAL HOLESAWS**

Part Number	Diameter mm	Length	Unit Pack Qty	List Price(₹)
2608584797* New! 2608594456	54	20	1	1047/ 570
2608584798* New! 2608594457	57	20	1	1,008/ 590
2608584800* New! 2608594459	64	20	1	1,037/ 610
2608584801* New! 2608594460	65	20	1	1,061/ 630
2608584804* New! 2608594463	70	20	1	1,258/ 670
2608584806* New! 2608594465	76	20	1	1,218/ 690
2608584811* New! 2608594470	102	20	1	1,811/ 920

*New part number prices will be revised post clearance of old stock.

**ACCESSORIES FOR SHEET
METAL HOLESAWS**
NEW!

Part Number	Description	Unit Pack Qty	List Price(₹)
2608594256	Power change plus adapter, 8.7mm Hex shank, with HSS-Co pilot drill bit, for holesaw diameter of 16-152 mm	1	1,474
2608594257	HSS-Co pilot drill bit Ø 7.15x65 mm, for new power change plus adapter	1	442

**ACCESSORIES FOR SHEET
METAL HOLESAWS**

Part Number	Description	Unit Pack Qty	List Price(₹)
2608584750	HSS-Co pilot drill bit with 1/4" hex shank, 1350 point angle and split point, 1 - 65 mm	1	716



HACKSAW FRAME AND BLADE



BENEFITS/WHY BOSCH?

- ▶ The hacksaw BiM delivers excellent performance in handheld applications.

- ▶ Complete solutions (blade + frame) which does not lock in the cutting material at affordable price.

MATERIALS:

PVC pipes, metallic conductors, optic fiber cables, copper cable, metal sheets, nails, etc.

HACKSAW FRAME



Part Number	Description	Unit Pack Qty	List Price(₹)
2608003031	Hacksaw Frame	1	522

HACKSAW BLADES



Part Number	Description	Unit Pack Qty	List Price(₹)
2608003027	Hacksaw 18 T blister pack	2	160
2608003028	Hacksaw 24 T blister pack	2	160
2608003029	Hacksaw 32 T blister pack	2	160

HACKSAW BLADES



Part Number	Description	Unit Pack Qty	List Price(₹)
2608003024	Hacksaw 18 T box	50	70
2608003025	Hacksaw 24 T box	50	70
2608003026	Hacksaw 32 T box	50	70

*In the multiples of 50 Only









JIGSAW BLADES



WOOD

JIGSAW BLADES FOR WOOD

The classics.

								
Available blade types	5	2	1	1	5	5	4	3
T-Shank	✓	✓	✓	✓	✓	✓	✓	✓
U-Shank	✓	-	-	✓	-	✓	✓	✓
MATERIALS								
Softwood	-	-	-	✓	✓	✓	✓	✓
Plywood	-	-	-	✓	✓	✓	-	-
Hardwood, chipboard, MDF	✓	✓	-	-	-	-	-	-
Laminated boards, kitchen worktops	✓	-	-	-	-	-	-	-
Laminate, vinyl flooring	-	-	✓	-	-	-	-	-
WPC (wood plastic composites)	-	-	-	-	-	-	-	-
Construction wood	-	✓	-	-	✓	-	✓	-

JIGSAW BLADES

Transition to new part numbers



OLD Part Number	NEW Part Number	NEW Description	Total Length mm	Unit Pack Qty	List Price(₹)
2608630037*	2608630030	T 101 B-HCS, ground teeth and tape ground softwood, chipboard, wood core plywood, fibre boards (3-30 mm), plastics/ epoxy (diameter <30 mm)	100	5	353
T 119 B (Basic for wood)	(Clean for wood)				

JIGSAW BLADES

Basic for Wood



Part Number	Description	Total Length mm	Unit Pack Qty	List Price(₹)
2608630310	T 119 BO - HCS, wavy set, milled softwood (2-15 mm), plywood, chipboard, wood core plywood, fibre boards, especially for curve cuts	83	5	414
2608637879	T 119 BO - HCS, wavy set, milled softwood (2-15 mm), plywood, chipboard, wood core plywood, fibre boards, especially for curve cuts	83	100	3,467
2608630033	T 111 C - HCS, side set, milled softwood (4-50 mm), chipboard, wood core plywood, fibre boards, quick cut	100	5	256
2608637878	T 111 C - HCS, side set, milled softwood (4-50 mm), chipboard, wood core plywood, fibre boards, quick cut	100	100	4,746

JIGSAW BLADES

Speed for Wood



Part Number	Description	Total Length mm	Unit Pack Qty	List Price(₹)
2608630040	T 144 D Speed for Wood, Jigsaw Blade delivers fast, straight cuts in wood	100	5	250
2608637880	T 144 D - HCS, side set, ground softwood (5-50 mm), chipboards, wood core plywood, fibre boards	100	100	4,360
2608630058	T 244 D - HCS, side set, ground softwood (5-50 mm), chipboards, wood core plywood, fibre boards, especially for curve cuts	100	5	294
2608637881	T 244 D - HCS, side set, ground softwood (5-50 mm), chipboards, wood core plywood, fibre boards, especially for curve cuts	100	100	4,655
2608637944	T 344 D Speed for Wood, Jigsaw Blade makes fast, straight cuts in wood	152	3	279
2608663314	T 744 D - HCS, side set, ground softwood/ boards, thick construction timber, sandwich materials	180	3	2,123

JIGSAW BLADES

Precision for Wood



Part Number	Description	Total Length mm	Unit Pack Qty	List Price(₹)
2608633A35	T 144 DP - HCS, side set, ground softwood, chipboards, wood core plywood, fibre boards (5-50 mm), doors, kitchen worktops (<50 mm)	100	5	512

*For Tooth spacing details please refer Annexure.

JIGSAW BLADES Progressor for Wood



Part Number	Description	Total Length mm	Unit Pack Qty	List Price (₹)
2608633528	T 234 X - HCS , ground teeth and taper ground softwood (3-65 mm), chipboards, wood core plywood, fibre boards	117	5	860

JIGSAW BLADES Clean for Wood



Part Number	Description	Total Length mm	Unit Pack Qty	List Price (₹)
2608630031	T 101 AO - HCS, pointed teeth, ground teeth and taper ground softwood, plywood, laminated panels (1.5-15 mm), especially for curve cuts	83	5	356
2608630014	T 101 B - HCS, ground teeth and taper ground softwood, chipboard, wood core plywood, fibre boards (3-30 mm), plastics/epoxy (diameter <30 mm)	100	5	345
2608630032	T 101 D - HCS, ground teeth and taper ground softwood, chipboards, wood core plywood, fibre boards (10-45 mm)	100	5	359
2608637590	T 301 CD - HCS, ground teeth and taper ground softwood, chipboards, wood core plywood, fibre boards (10-65 mm)	117	5	458
2608637876	T 101 B - HCS, ground teeth and taper ground softwood, chipboard, wood core plywood, fibre boards (3-30 mm), plastics/epoxy (diameter <30 mm)	100	100	5,806
2608637877	T 101 D - HCS, ground teeth and taper ground softwood, chipboards, wood core plywood, fibre boards (10-45 mm)	100	100	5,784

HARD WOOD

JIGSAW BLADES Speed for Hard Wood



Part Number	Description	Total Length mm	Unit Pack Qty	List Price (₹)
2608634567	T 144 DF - BIM , side set, ground hardwood and softwood (5-50 mm), all types of panels, including laminates	100	5	746
2608634243	T 344 DF - BIM , side set, ground thick hardwood and softwood (5-50 mm), all types of panels, including laminates	152	5	1,910

JIGSAW BLADES Clean for Hard Wood



Part Number	Description	Total Length mm	Unit Pack Qty	List Price (₹)
2608634234	T 101 BF - BIM , ground teeth and taper ground hardwood, laminated panels/HPL (3-30 mm), glass fibre reinforced plastic/epoxy (diameter <30 mm)	100	5	1,538

JIGSAW BLADES Special for Laminate



Part Number	Description	Total Length mm	Unit Pack Qty	List Price (₹)
2608636432	T 101 AOF - BIM, ground teeth and taper ground laminates (1.5 - 15 mm), laminated panels/HPL (1.5 - 15 mm), multiplex panels (1.5 - 15 mm)	83	3	876

*For Tooth spacing details please refer Annexure.



WOOD & METAL

JIGSAW BLADES FOR WOOD AND METAL

Nails? No problem.



Progressor for Wood and Metal

Available blade types	1
T-Shank	✓
U-Shank	-

MATERIALS

Construction timber with hardened screws and nails	-
Construction timber with nails	✓
Profiles, pipes, thickwalled	✓
Aluminium, non-ferrous metals	✓
Glass fibre reinforced plastic/epoxy	✓

JIGSAW BLADES For Wood and Metal



Part Number	Description	Unit Pack Qty	List Price (₹)
2609256743 New! 2607010515	T123X: 100 mm T345XF: 132 mm T234X: 116 mm	3	234
2609256737 New! 2608655101	T345XF: 65 mm	1	179
2609256729	T118 A: 92 mm	3	137
2609256736 New! 2608668706	T127D: 30 mm	3	141

JIGSAW BLADES Progressor for Wood & Metal

PRO



Part Number	Description	Total Length mm	Unit Pack Qty	List Price (₹)
2608634994	T 345 XF - BiM, side set, milled construction timber with nails (<65 mm), wooden materials, plastics, sheet metals, pipes/profiles, including aluminium (diameter 3-10 mm)	132	5	989

METAL

JIGSAW BLADES FOR METAL

Make the cut you need.



Basic for Inox Progressor for Metal Speed for Metal Flexible for Metal Basic for Metal Special for Alu Flexible for Metal-Sandwich Precision for Metal-Sandwich

Available blade types	2	1	5	5	6	2	1	1
T-Shank	✓	✓	✓	✓	✓	✓	✓	✓
U-Shank	-	-	-	-	✓	✓	-	-
MATERIALS								
Sheet metal	-	✓	✓	✓	✓	-	-	-
Perforated sheet metal	-	✓	✓	✓	-	-	-	-
Aluminium, non-ferrous metals	-	✓	-	-	-	✓	-	-
Stainless steel sheets	✓	-	-	-	-	-	-	-
Profiles, pipes (closed)	-	-	✓	✓	✓	-	-	-
Profiles (open)	-	-	✓	✓	-	-	-	-
Metal sandwich	-	-	-	-	-	-	✓	✓

*For Tooth spacing details please refer Annexure.

METAL

JIGSAW BLADES

Transition to new part numbers



OLD Part Number	NEW Part Number	NEW Description	Total Length mm	Unit Pack Qty	List Price (₹)
2608631032* T 218 A (Basic for Metal)	2608634237 (Flexible for Metal)	T 118 EOF - BiM, wavy set, milled thin sheet metals, perforated sheet metals (1.5-4 mm), especially for curve cuts	83	5	968
2608631319* T 318 A (Basic for Metal)	2608636705 (Speed for Metal)	T 321 AF - BiM, wavy set, milled thin sheet metals, perforated sheet metals (1-3 mm), sandwich materials (<65 mm), thin-walled pipes, closed + open profiles, including aluminium (<65 mm), glass fibre reinforced plastic/ epoxy (<65 mm), glass fibre reinforced plastic/ epoxy (<65 mm)	132	5	392
2608631706* T 218 A (Basic for Metal)	2608634237 (Flexible for Metal)	T 118 EOF - BiM, wavy set, milled thin sheet metals, perforated sheet metals (1.5-4 mm), especially for curve cuts	83	5	968
2608631404* T 318 B (Basic for Metal)	2608636707 (Speed for Metal)	T 321 BF - BiM, wavy set, milled medium-thick sheet metals, perforated sheet metals (2.5-6 mm), sandwich materials (<65 mm), thick walled pipes, closed + open profiles, including aluminium (<65 mm), glass fibre reinforced plastic/epoxy (<65 mm)	132	5	405
2608636699 T 118 AF (Flexible for Metal)	2608655106 (Speed for Metal)	T 118 EOF - BiM, wavy set, milled thin sheet metals, perforated sheet metals (1.5-4 mm), especially for curve cuts	92	5	430

JIGSAW BLADES

Basic for Metal



Part Number	Description	Total Length mm	Unit Pack Qty	List Price (₹)
2608631013	T 118 A - HSS, wavy set, milled thin sheet metals (1-3 mm)	92	5	205
2608631964	T 118 A - HSS, wavy set, milled thin sheet metals (1-3 mm)	92	100	3,833
2608631965	T 118 B - HSS, wavy set, milled medium-thick sheet metals (2.5-6 mm)	92	100	4,247
2608631012	T 118 G - HSS, wavy set, milled very thin sheet metals (0.5 - 1.5 mm)	92	5	337

JIGSAW BLADES

Flexible for Metal



Part Number	Description	Total Length mm	Unit Pack Qty	List Price (₹)
2608634774 New! 2608655108	T 118 AF - BiM, wavy set, milled thin sheet metals, perforated sheet metals (1-3 mm)	92	100	4545
2608634503	T 118 BF - BiM, wavy set, milled medium-thick sheet metals, perforated sheet metals (2.5-6 mm)	92	5	386

JIGSAW BLADES

Speed for Metal

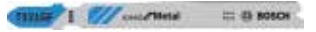

Part Number	Description	Total Length mm	Unit Pack Qty	List Price (₹)
2608636696 New! 2608655104	T 121 GF - BiM, wavy set, milled very thin sheet metals, perforated sheet metals (0.5-1.5 mm)	92	5	421
2608636697	T 121 GF - BiM, wavy set, milled very thin sheet metals, perforated sheet metals (0.5-1.5 mm)	92	25	1,983
2608636700 New! 2608655107	T 121 AF - BiM, wavy set, milled thin sheet metals, perforated sheet metals (1-3 mm)	92	25	1,963
2608636702 New! 2608655110	T 121 BF - BiM, wavy set, milled medium-thick sheet metals, perforated sheet metals (2.5-6 mm)	92	5	347

JIGSAW BLADES

Flexible for Metal-Sandwich



Part Number	Description	Total Length mm	Unit Pack Qty	List Price (₹)
2608636335	T 718 BF - BiM, wavy set, milled sandwich materials (<120 mm)	180	3	2,081

*Available till stocks last

*For Tooth spacing details please refer Annexure.

METAL

JIGSAW BLADES Progressor for Metal



Part Number	Description	Total Length mm	Unit Pack Qty	List Price (₹)
2608638473	T 123 X - HSS, side set, milled thin to thick sheet metals (1.5-10 mm), pipes + profiles, including aluminium (diameter <30 mm)	100	5	360
2608638474	T 123 X - HSS, side set, milled thin to thick sheet metals (1.5-10 mm), pipes + profiles, including aluminium (diameter <30 mm)	100	25	1,727

JIGSAW BLADES Expert - Stainless Steel



NEW Expert Part Number	Description	Total Length mm	Unit Pack Qty	List Price (₹)
2608900561	T 118 AHM - Tungsten carbide tipped (bar), ground thin, stainless steel sheets (Inox) (1.5-3 mm)	83	3	1,595
2608900562	T 118 EHM - Tungsten carbide tipped (bar), ground medium-thick stainless steel sheets (Inox) (2-5 mm)	83	3	1,599

JIGSAW BLADES Stainless Steel



Part Number	Description	Unit Pack Qty	List Price (₹)
2608630663	RB - 3ER T 118 AHM	1	1,595
2608630665	RB - 3ER T 118 EHM	1	1,599

JIGSAW BLADES Special for Fiber and Plaster



Part Number	NEW Part Number	Description	Unit Pack Qty	List Price (₹)
2608633175	2608900563	T 141 HM	1	2,752
2608633176		T 341 HM	1	3,655

*Available till stocks last

JIGSAW BLADES Special for Aluminium



Part Number	Description	Total Length mm	Unit Pack Qty	List Price (₹)
2608631017	T 127 D - HSS, side set, milled thin to thick sheet metals (3-15 mm), pipes + profiles, (diameter <30 mm)	100	5	242
2608631966	T 127 D - HSS, side set, milled thin to thick sheet metals (3-15 mm), pipes + profiles, (diameter <30 mm)	100	100	4,458
2608631030	T 227 D - HSS, side set, milled thin to thick sheet metals (3-15 mm), pipes + profiles (diameter <30 mm), especially for curve cuts	100	5	397
2608638382	T 227 D - HSS, side set, milled thin to thick sheet metals (3-15 mm), pipes + profiles (diameter <30 mm), especially for curve cuts	100	100	7,163

JIGSAW BLADES Special for Soft Material



OLD Part Number	NEW Part Number	NEW Description	Total Length mm	Unit Pack Qty	List Price (₹)
2608635177*	2608635187	T 313 AW - HCS, blade with serrated edgcardboard, polystyrene, carpet, leather, rubber (<100 mm)	152	3	1,127
	T 113 A				

*For Tooth spacing details please refer Annexure.



SPECIAL MATERIAL

JIGSAW BLADES FOR SPECIAL APPLICATIONS

Unusual jigsaw jobs.



Available blade types	1	2	1
T-Shank	✓	✓	✓
U-Shank	-	-	-

MATERIALS

Drywall board, fiber cement board	-	-	-
Porous concrete	-	-	-
Ceramic tiles	✓	-	-
Polystyrene, cardboard	-	✓	✓
Rubber	-	✓	-
Fiber insulation materials	-	✓	✓

JIGSAW BLADES Expert – Fiber Plaster



NEW EXPERT Part Number	Description	Total Length mm	Unit Pack Qty	List Price (₹)
2608900563	T 141 HM - Tungsten carbide tipped, side set glass fibre reinforced plastic/epoxy (5-20 mm), plasterboard, fibre cement boards (5-50 mm)	100	3	2,752
2608900564	T 341 HM - Tungsten carbide tipped, side set glass fibre reinforced plastic/epoxy (5-50 mm), plasterboard, fibre cement boards (<80 mm)	132	3	3,654

CARBIDE
BLADE

JIGSAW BLADES Special for Ceramic



Part Number	Description	Total Length mm	Unit Pack Qty	List Price (₹)
2608633105 New! 2608900567	T 150 RIFF - Tungsten carbide coated, with grit of 50 soft ceramic wall tiles, cast iron (5-10 mm), fine cut	83	3	762
2608633104	T 130 RIFF - suitable for with carbide coating, for plaster board, fibre cement boards,	83	3	755

JIGSAW BLADES Special for Acrylic



Part Number	Description	Total Length mm	Unit Pack Qty	List Price (₹)
2608631010	T 101 A - HSS, ground teeth and taper ground Perspex, polycarbonate (2-20 mm)	100	5	519

JIGSAW BLADES Blade Pair for Foam Rubber Cutters



Part Number	Total Length mm	Unit Pack Qty	List Price (₹)
2607018010	130	2	1,289
2607018011	220	2	1,414

*For Tooth spacing details please refer Annexure.



Technical Details for Jigsaw Blades

Part Number	Model	Total Length mm	Unit Pack Qty	Tooth Spacing	Material	List Price (₹)
2608630030	T 101 B	100	5	2.7	HCS	353
2608630310	T 119 BO	83	5	2	HCS	414
2608637879	T 119 BO	83	100	2	HCS	3,467
2608630033	T 111 C	100	5	3	HCS	256
2608637878	T 111 C	100	100	3	HCS	4,746
2608630040	T 144 D	100	5	4-5.2	HCS	250
2608637880	T 144 D	100	100	4-5.2	HCS	4,360
2608630058	T 244 D	100	5	4-5.2	HCS	294
2608637881	T 244 D	100	100	4-5.2	HCS	4,655
2608637944	T 344 D	152	3	4	HCS	279
2608663314	T 744 D	180	3	4	HCS	2,123
2608633A35	T 144 DP	100	5	4	HCS	512
2608633528	T 234 X	117	5	2.0-3.0	HCS	860
2608630031	T 101 AO	83	5	1.4	HCS	356
2608630014	T 101 BR	100	5	2.5	HCS	345
2608630032	T 101 D	100	5	4-5.2	HCS	359
2608637590	T 301 CD	117	5	3.00	HCS	458
2608637876	T 101 B	100	100	2.7	HCS	5,806
2608637877	T 101 D	100	100	4-5.2	HCS	5,784
2608634567	T 144 DF	100	5	4-5.2	BiM	746
2608634243	T 344 DF	152	5	4	BiM	1,910
2608634234	T 101 BF	100	5	2.7	BiM	1,538
2608636432	T 101 AOF	83	3	1.4	BiM	876
2608634994	T 345 XF	132	5	2.4-5	BiM	989
2608634237	T 118 EOF	83	5	1.5	BiM	968
2608636705	T 321 AF	132	5	1.2	BiM	392
2608636707	T 321 BF	132	5	2	BiM	405
2608636699	T 121 AF	92	5	1.2	BiM	430
2608631013	T 118 A	92	5	1.1-1.5	HSS	205
2608631964	T 118 A	92	100	1.1-1.5	HSS	3,833
2608631965	T 118 B	92	100	1.9-2.3	HSS	4,247
2608631012	T 118 G	92	5	0.7	HSS	337
2608634774, New! 2608655108	T 118 AF	92	100	1.1-1.5	HSS	4,545
2608634503	T 118 BF	92	5	1.9-2.3	HSS	386
2608636696, New! 2608655104	T 121 GF	92	5	0.8	HSS	421
2608636697	T 121 GF	92	25	0.8	HSS	1,983
2608636700, New! 2608655107	T 121 AF	92	25	1.2	BiM	1,963
2608636702, New! 2608655110	T 121 BF	92	5	2	BiM	347
2608636335	T 718 BF	180	3	2	BiM	2,081
2608638473	T 123 Xf	100	5	1.2-2.6	BiM	360
2608638474	T 123 Xf	100	25	1.2-2.6	BiM	1,727
2608900561	T 118 AHM	83	3	1.1	Carbide	1,595
2608900562	T 118 EHM	83	3	1.4	Carbide	1,599
2608631017	T 127 D	100	5	3	HSS	242
2608631966	T 127 D	100	100	3	HSS	4,458
2608631030	T 227 D	100	5	3	HSS	397
2608638382	T 227 D	100	100	3	HSS	7,163
2608635187	T 313 AW	152	3	3	HCS	1,127
2608633105	T 150 RIFF	83	3	-	Carbide	762
2608900563	T 141 HM	100	3	4.3	Carbide	2,752
2608900564	T 341 HM	132	3	4.3	Carbide	3,654
2608631010	T 101 A	100	5	2	HSS	519

RECIPROCATING SAW/ SABRE SAW BLADES



ENDURANCE FOR VEHICLE RESCUE

Bosch Carbide Technology

SABRE SAW BLADES Expert - Vehicle Rescue

*Old Part number available till stocks last



OLD Part Number	NEW EXPERT Part Number	Description	Total Length mm	Unit Pack Qty	List Price (₹)
2608653130*	2608900378	S 957 CHM - Carbide Technology, constant tooth pitch. Cutting of vehicles thanks to individually welded teeth	150	1	1,803

*Available till stocks last

SABRE SAW BLADES Expert - Vehicle Rescue



NEW EXPERT Part Number	Description	Total Length mm	Unit Pack Qty	List Price (₹)
2608900380	S 1157 CHM - Carbide Technology, constant tooth pitch. Cutting of vehicles thanks to individually welded teeth	225	1	2,527

*For TPI and more technical details please refer Annexure

METAL

SABRE SAW BLADES Transition to new part numbers



OLD Part Number	NEW Part Number	NEW Description	Total Length mm	Unit Pack Qty	List Price (₹)
-----------------	-----------------	-----------------	-----------------	---------------	----------------

2608651780***2608656013 S 922 AF** - BiM, 150 5 1,141
S 918 AF (Flexible for wavy set, milled thin sheet metals (0.7-3 mm), fine pipes/profiles (diameter <100 mm), effortless, fine cut
 (Basic for Metal)

2608651781***2608656014 S 922 BF** - BiM, 150 5 1,243
S 918 BF (Flexible for side set, milled thick sheet metals (3-8 mm), solid pipes/profiles (diameter <100 mm), quick cut
 (Basic for Metal)

SABRE SAW BLADES Heavy for Metal



Part Number	Description	Total Length mm	Unit Pack Qty	List Price (₹)
-------------	-------------	-----------------	---------------	----------------

2608654820 **S 920 CF** - BiM, patented 2x2 tooth geometry thick sheet metals (4-12 mm),
New!

2608657527 thick-walled, solid pipes and profiles (<100 mm), ideal for pipe cutting device, for rescue/demolition work, powerful, coarse cut

2608656255 **S 1120 CF** - BiM, patented 2x2 tooth geometry thick sheet metals (4-12 mm), thick-walled, solid pipes and profiles (<100 mm), ideal for pipe cutting device, for rescue/demolition work, powerful, coarse cut

2608657409 **S 1225 VF** - BiM, vario-pitched teeth medium-thick to thick sheet metals (2-10 mm), thin-walled and thick-walled pipes and profiles (<250 mm), ideal for demolition work in metal. Effortless, fine cut

2608657407 **S 925 VF** - BiM, vario-pitched teeth Medium-thick to thick sheet metals (2-10 mm), thin-walled and thick-walled pipes and profiles (<100 mm). Ideal for demolition work in metal. Effortless, fine cut

2608657408 **S 1125 VF** - BiM, vario-pitched teeth. Medium-thick to thick sheet metals (2-10 mm), thin-walled and thick-walled pipes and profiles (<175 mm). Ideal for demolition work in metal. Effortless, fine cut.

2608656265 **S 1025 VF** Heavy for Metal Reciprocating Saw Blade delivers effortless and smooth cuts in metal

SABRE SAW BLADES Progressor for Metal



Part Number	Description	Total Length mm	Unit Pack Qty	List Price (₹)
-------------	-------------	-----------------	---------------	----------------

2608654402 **S 123 XF** - BiM blade is engineered for cutting regular-strength steel pipes and profiles. It features a special tooth design for cutting steel materials with a variety of wall thicknesses from 1 mm to 8 mm

SABRE SAW BLADES Flexible for Metal



Part Number	Description	Total Length mm	Unit Pack Qty	List Price (₹)
-------------	-------------	-----------------	---------------	----------------

2608656018 **S 1122 AF** - BiM, wavy set, milled thin sheet metals (0.7-3 mm), fine pipes/profiles (diameter <175 mm), effortless, fine cut, flexible flush cut

2608656015 **S 922 EF** - BiM, side set, milled thin sheet metals (1.5-4 mm), pipes/profiles (diameter <100 mm)

2608656020 **S 1122 EF** - BiM, side set, milled thin sheet metals (1.5-4 mm), pipes/profiles (diameter <175 mm), flexible flush cut

2608656011 **S 522 BF** - BiM, side set, milled thick sheet metals (3-8 mm), quick cut

2608656019 **S 1122 BF** - BiM, side set, milled Thick sheet metals (3-8 mm), solid pipes/profiles (diameter <175mm), flexible flush cut, quick cut

2608656010 **S 522 AF** Flexible for Metal Reciprocating Saw Blade is designed for use with compact saws

2608656037 **S 922 BF** Flexible for Metal Reciprocating Saw Blade is optimised for fast cuts in metal

2608656041 **S 1122 BF** Flexible for Metal Reciprocating Saw Blade is optimised for flush cutting in metal

2608656042 **S 1122 EF** Flexible for Metal Reciprocating Saw Blade is optimised for flush cutting in metal

SABRE SAW BLADES

Endurance for Heavy Metal- BiM



Part Number	Description	Total Length mm	Unit Pack Qty	List Price (₹)
2608657524 New! 2608658994	S 1127 BEF - BiM, Micro Edge Geometry, patented 2x2 Tooth Geometry with Full Contact Design Medium-thick to thick sheet metals (3-8 mm), thin-walled closed and open profiles and pipes (<175 mm). Fine, precise cuts at accurate angles	225	5	1,517
2608657525 New! 2608658997	S 936 CHF - BiM, Micro Edge Geometry, patented 2x2 Tooth Geometry with Full Contact Design Medium-thick to thick sheet metals (3-8 mm), thin-walled closed and open profiles and pipes (<175 mm). Fine, precise cuts at accurate angles	150	5	2,326
2608657526 New! 2608658998	S 1136 CHF - BiM, Micro Edge Geometry, patented 2x2 Tooth Geometry Thick sheet metals (4-12 mm), thick-walled closed and open profiles and pipes (<175 mm). Fast, precise cuts at accurate angles	225	5	1,786
2608657528	S 1130 CF - BiM, Micro Edge Geometry, patented 2x2 Tooth Geometry Thick sheet metals (4-12 mm), thick-walled, solid pipes and profiles (<175 mm). Ideal for pipe cutting device, for rescue/demolition work. Powerful, coarse cut	225	5	1,786

SABRE SAW BLADES

Expert Thick Tough Metal
EXPERT



NEW EXPERT Part Number	Description	Total Length mm	Unit Pack Qty	List Price (₹)
2608900365	S 955 CHM - Carbide Technology, constant tooth pitchcutting of high strength steels thanks to individually welded teeth	150	1	1,856
2608900368	S 1155 CHM - Carbide Technology, constant tooth pitch cutting of high strength steels thanks to individually welded teeth	225	1	2,602

SABRE SAW BLADES

Expert - Thin Tough Metal
EXPERT



NEW EXPERT Part Number	Description	Total Length mm	Unit Pack Qty	List Price (₹)
2608900359	S 522 EHM - Carbide Technology (bar), teeth ground Especially optimised for use in compact saws. Inox sheets (2-4 mm), inox profiles (diameter <50 mm), glass fibre reinforced plastic/epoxy (<50 mm)	115	1	2,414
2608900360	S 922 EHM - Carbide Technology (bar), teeth ground Inox sheets (2-4 mm), inox profiles (diameter <100 mm), glass fibre reinforced plastic /epoxy (<100 mm)	150	1	2,863

SABRE SAW BLADES

Expert - Vehicle Rescue

CARBIDE BLADE



OLD Part Number	NEW EXPERT Part Number	Description	Total Length mm	Unit Pack Qty	List Price (₹)
2608653130	2608900378	S 957 CHM - Carbide Technology, constant tooth pitch. Cutting of vehicles thanks to individually welded teeth	150	1	1,856
	2608900380	S 1157 CHM - Carbide Technology, constant tooth pitch. Cutting of vehicles thanks to individually welded teeth	225	1	2,602

WOOD & METAL

SABRE SAW BLADES

Progressor for Wood and Metal



Part Number	Description	Total Length mm	Unit Pack Qty	List Price (₹)
2608654406	S 3456 XF - BiM, side set, milled wood with nails/ met- metal, chipboard (<150 mm), sheet metals, aluminium profiles (3-18 mm), glass fibre reinforced plastic/epoxy (<150 mm)	200	5	2,209

*For TPI and more technical details please refer Annexure

SABRE SAW BLADES Heavy for Wood and Metal



Part Number	Description	Total Length mm	Unit Pack Qty	List Price (₹)
2608656258	S 611 DF - BIM, side set, milled wood with nails/metal, chipboard (<100 mm), plastic profiles (<100 mm), glass fibre reinforced plastic/epoxy (<50 mm), window frames: wood + metal, especially for plunge cuts	150	5	935
2608654763	S 1411 DF - BIM, side set, milled wood with nails/metal, chipboard (<250 mm), glass fibre reinforced plastic/epoxy (<60 mm)	300	5	1,839

SABRE SAW BLADES Flexible for Wood & Metal



Part Number	Description	Total Length mm	Unit Pack Qty	List Price (₹)
2608657560	S 1122 HF - BIM, side set, milled for pallet repair, wood with nails/metal (<175 mm), sheet metals, pipes, aluminium profiles (3-12 mm), flexible flush out	225	25	10,185
2608656039	S 922 HF Flexible for Wood and Metal Reciprocating Saw Blade makes cuts in wood and metal	150	2	480
2608656043	S 1222 VF Flexible for Wood and Metal Reciprocating Saw Blade delivers effortless flush cuts in wood and metal	300	2	891

SABRE SAW BLADES Expert- Multi Material



OLD Part Number	NEW EXPERT Part Number	Description	Total Length mm	Unit Pack Qty	List Price (₹)
2608653100	2608900391	S 1156 XHM - Carbide Technology, side set, ground Wood with (hardened) nails/ metal (5-175 mm), wood with steel elements (5-175 mm), cast steel pipes (diameter <6"), glass fibre reinforced plastic/epoxy (<175 mm)	225	1	2,602

WOOD

SABRE SAW BLADES

Transition to new part numbers



OLD Part Number	NEW EXPERT Part Number	Description	Total Length mm	Unit Pack Qty	List Price (₹)
2608650617*	2608650681 S 1111 K (Basic for wood)	S 1542 K Basic for Wood Reciprocating Saw Blade makes cuts in wood	240	2	497

SABRE SAW BLADES Basic for Wood



Part Number	Description	Total Length mm	Unit Pack Qty	List Price (₹)
2608650616	S 617 K Basic for Wood Reciprocating Saw Blade delivers curved and plunge cuts in wood	150	2	389

SABRE SAW BLADES Top for Wood



Part Number	Description	Total Length mm	Unit Pack Qty	List Price (₹)
2608650613	S 1531 L - HCS, Top for Wood Reciprocating Saw Blade delivers clean fast cuts for pruning wooden materials	240	2	444
2608650673	S 644 D - HCS, side set, ground construction wood (<100 mm), wooden wall (<100 mm), boards: chipboard, MDF (6-60 mm), plywood, plastic (<100 mm), especially for plunge cuts	150	5	637
2608650676	S 1531 L - HCS, side set, ground coarse wood, free of nails (<190 mm), pruning green wood (diameter <190 mm), firewood (diameter <190 mm)	240	5	1,026

SABRE SAW BLADES Progressor for Wood



Part Number	Description	Total Length mm	Unit Pack Qty	List Price (₹)
2608654404	S 2345 X - HCS, side set, ground construction wood (<150 mm), boards: chipboard, MDF (6-60 mm), plywood, plastic (<150 mm), wooden wall (<150 mm), effortless, fine cut	200	5	2,044

SPECIAL MATERIAL

SABRE SAW BLADES Special for Ice



Part Number	Description	Total Length mm	Unit Pack Qty	List Price (₹)
2608652900	S 1211 K - Stainless steel (Inox), side set, milled frozen materials (<250 mm)	300	5	1,014

SABRE SAW BLADES Expert - Aerated Concrete **EXPERT**



NEW EXPERT Part Number	Description	Total Length mm	Unit Pack Qty	List Price (₹)
2608900410	S 1241 HM - TC, side set, ground porous concrete, red brick, fibre cement (<250 mm), glass fibre reinforced plastic/epoxy (<150 mm), for abrasive materials	300	1	1,464

2608900413	S 2041 HM - TC, side set, ground porous concrete, red brick, fibre cement (<350 mm), glass fibre reinforced plastic/epoxy (<150 mm), for abrasive materials	400	1	1,872
------------	--	-----	---	-------

SABRE SAW BLADES



Part Number	NEW! Part Number	Unit Pack Qty	List Price (₹)
2608653180	2608900365	1	1,857
2608653132	2608900380	1	2,602
2608653096	2608900359	1	2,414
2608653097	2608900360	1	2,863
2608653182	2608900368	1	2,602

SABRE SAW BLADES Special for Plaster



Part Number	Description	Total Length mm	Unit Pack Qty	List Price (₹)
2608656274	S 628 DF Special for Plaster Reciprocating Saw Blade delivers clean curved cuts in special materials	150	2	492

SABRE SAW BLADES Expert - Hollow Brick



NEW EXPERT Part Number	Description	Total Length mm	Unit Pack Qty	List Price (₹)
----------------------------------	-------------	-----------------	---------------	----------------

2608900417	S 1243 HM - TC-tipped, for medium-sized bricks up to a material thickness of 215 mm	305	1	4,846
------------	--	-----	---	-------

2608900418	S 2243 HM - TC-tipped, for large bricks up to a material thickness of 365 mm	455	1	8,380
------------	---	-----	---	-------

*For TPI and more technical details please refer Annexure



Technical Details

Part Number	Model	Unit Pack Qty	Tooth Spacing	TPI	Dimensions	Max Cut Capacity of Blade	Blade Material	Recommended Min Material Thickness	Recommended Max Material Thickness
2608900418	S 2243 HM	1	12.7	2	455x50x1.5	405	Carbide Teeth	-	-
2608900417	S 1243 HM	1	12.7	2	300x50x1.5	250	Carbide Teeth	-	-
2608900413	S 2041 HM	1	12.7	2	400x22x1.5	350	Carbide Teeth	-	-
2608900410	S 1241 HM	1	8.5	3	300x22x1.5	250	Carbide Teeth	-	-
2608900391	S 1156 XHM	1	3.0-4.0	6-8	225x25x1.25	175	Carbide Teeth	-	-
2608900380	S 1157 CHM	1	3	8	225x2x1.35	-	Carbide Teeth	4	12
2608900378	S 957 CHM	1	3	8	150x20x1.35	-	Carbide Teeth	4	12
2608900368	S 1155 CHC	1	3	8	225x25x1.25	175	Carbide Teeth	4	12
2608900365	S 955 CHC	1	3	8	150x25x1.25	100	Carbide Teeth	4	12
2608900360	S 922 EHM	1	1.4	18	150x19x1	-	Carbide Teeth	1.5	-
2608900359	S 522 EHM	1	1.4	18	115x19x1	-	Carbide Teeth	1.5	4
2608657560	S 1122 HF	25	2.5	10	225x19x0.9	175	BiM	-	-
2608657528	S 1130 CF	5	2.5+3.2	8+10	225x22x1.6	175	BiM	4	12
2608657526	S 1136 CHF	5	2.5+3.2	8+10	225x25x1.1	175	BiM	4	12
2608657525	S 936 CHF	5	2.5+3.2	8+10	150x25x1.1	100	BiM	4	12
2608657524	S 1127 BEF	5	1.4+1.8	14+18	225x25x1.1	175	BiM	2	6
2608657409	S 1225 VF	5	1.8-2.6	10-14	300x19x1.25	250	BiM	2.5	10
2608657408	S 1125 VF	5	1.8-2.6	10-14	225x19x1.25	175	BiM	2.5	10
2608657407	S 925 VF	5	1.8-2.6	10-14	150x19x1.25	100	BiM	2.5	10
2608656274	S 628 DF	2	4.2	6	150x19x1.25	100	BiM	-	-
2608656265	S 1025 VF	5	1.8-2.6	10-14	200x19x1.25	150	BiM	2.5	10
2608656258	S 611 DF	5	4.3	6	150x22x1.25	100	BiM	-	-
2608656255	S 1120 CF	5	2.5+3.2	8+10	225x22x1.6	175	BiM	4	12
2608656043	S 1222 VF	2	1.8-2.6	10-14	300x19x0.9	250	BiM	-	-
2608656042	S 1122 EF	2	1.4	18	225x19x0.9	175	BiM	1.5	4
2608656041	S 1122 BF	2	2	14	225x19x0.9	175	BiM	2.5	8
2608656039	S 922 HF	2	2.5	10	150 x19x0.9	100	BiM	-	-
2608656037	S 922 BF	2	2	14	150x19x0.9	100	BiM	2.5	8
2608656020	S 1122 EF	5	1.4	18	225x19x0.9	175	BiM	1.5	4
2608656019	S 1122 BF	5	2	14	225x19x0.9	175	BiM	2.5	8
2608656018	S 1122 AF	5	1.1	24	225x19x0.9	175	BiM	0.7	2
2608656015	S 922 EF	5	1.4	18	150x19x0.9	100	BiM	1.5	4
2608656014	S 922 BF	5	2	14	150x19 x0.9	-	BiM	2.5	8
2608656013	S 922 AF	5	1.1	24	150x19 x0.9	-	BiM	0.7	2
2608656011	S 522 BF	5	2	14	100x19x0.9	-	BiM	2.5	8
2608656010	S 522 AF	5	1	24	100x19x0.9	-	BiM	0.7	3
2608654820	S 920 CF	5	2.5+3.2	8+10	150x22x1.6	100	BiM	4	12
2608654763	S 1411 DF	5	4.3	6	300x19x1.25	250	BiM	-	-
2608654406	S 3456 XF	5	2.2-4.6	6-12	200x19x1.25	150	BiM	-	-
2608654404	S 2345 X	5	2.4-4.0	6-10	200x19x1.25	150	HCS	-	-
2608654402	S 123 XF	5	1.4-3.4	8-18	150x19x0.9	100	BiM	1	8
2608652900	S 1211 K	5	8.5	3	300x19x1.25	250	Stainless steel	-	-
2608650681	S 1542 K	2	8.5	3	240x19x1.5	190	HCS	-	-
2608650676	S 1531 L	5	5	5	240x19x1.5	190	HCS	-	-
2608650673	S 644 D	5	4	6	150x19x1.25	100	HCS	-	-
2608650616	S 617 K	2	8.5	3	150x19x1.25	100	HCS	-	-
2608650613	S 1531 L	2	5	5	240x19x1.5	190	HCS	-	-

ROUTER BIT SETS



ROUTER BIT SETS

FINE CUTS FOR A WIDE VARIETY OF APPLICATIONS.

Router Bit Sets for professional and enthusiastic woodworkers. Fit for all hand-held routers with 6 mm, 8 mm and 1/4" shank collet.



Comprehensive starter set with classical bit selection.

Mixed Router Bit Set, 15-Pieces.

Includes additional hex key and three ball bearings

Highly optimised selection of bits

- Grooving
- Rebating
- Grofiling
- Trimming

Value set for woodworkers, builders and installers.



Shank diameter

Ø 6 mm set : **2 607 017 471**

Ø 8 mm set : **2 607 017 472**

Ø 1/4" set : **2 607 017 473**

Trimming, chamfering and rounding.

Trim and Edging Router Bit Set, 6-Pieces.

Includes additional hex key and two ball bearings

Fast and clean cuts

- Razor sharp knives
- Fast and balanced rotation of ball bearings

Perfect for colt palm routers.



Shank diameter

Ø 6 mm set : **2 607 017 468**

Ø 8 mm set : **2 607 017 469**

Ø 1/4" set : **2 607 017 470**

Grooving and rebating.

Straight Router Bit Set, 6-Pieces.

Direct smooth plunge cuts

- Ø 12, 16 and 20 mm straight cutters equipped with a TC 3-cutter plunge tip

Extra depth of cuts

- 12, 16 and 20 mm straight shank bits offer a 30 mm cutting depth



Shank diameter

Ø 6 mm set : **2 607 017 465**

Ø 8 mm set : **2 607 017 466**

Ø 1/4" set : **2 607 017 467**

Complete woodworking set that covers most common applications.

Mixed Router Bit Set, 30-Pieces.

Includes additional hex key and three ball bearings

The complete set for all professional woodworking jobs

- Joinery
- Carpentry
- Furniture maker
- Interior fit-out
- Furniture installation



Shank diameter

Ø 6 mm set : **2 607 017 474**

Ø 8 mm set : **2 607 017 475**

Ø 1/4" set : **2 607 017 476**

*For price refer page 71

Part Number	Description	Shank Size	Tool to be used with	Unit Pack Qty	Unit List Piece (₹)
2607017465	6 Pcs Straight Bit Set	6 mm	GKF 550, GOF 130	6	2,043
2607017466	6 Pcs Straight Bit Set	8 mm	GOF 130	6	2,043
2607017467	6 Pcs Straight Bit Set	1/4 inch	GKF 550	6	2,043
New! 2607017468	6 Pc Trimming and Edging Set	6 mm	GKF 550, GOF 130	6	2,237
New! 2607017469	6 Pc Trimming and Edging Set	8 mm	GOF 130	6	2,237
New! 2607017470	6 Pc Trimming and Edging Set	1/4 inch	GKF 550	6	2,237
2607017471	15 Pcs Mixed Bit Set	6 mm	GKF 550, GOF 130	15	5,255
2607017472	15 Pcs Mixed Bit Set	8 mm	GOF 130	15	5,255
2607017473	15 Pcs Mixed Bit Set	1/4 inch	GKF 550	15	5,255
New! 2607017474	30 Pcs Mixed Bit Set	6 mm	GKF 550, GOF 130	30	9,037
New! 2607017475	30 Pcs Mixed Bit Set	8 mm	GOF 130	30	9,037
New! 2607017476	30 Pcs Mixed Bit Set	1/4 inch	GKF 550	30	9,037



PRO ROUTER BIT SINGLE PC















▶ Carbide cutting edges enable 2.5 Longer cutting time









































▶ “Easy-Pick” feature allows for the bits to be taken out easily and safely by the shank to avoid injuries

















▶ Fits all hand-held routers with 6 mm, 8 mm or 1/4" shank collet

▶ Free hex key and ball bearings

▶ Highest level of productivity and safety according to EN 847 Standard

Part Number	Material Description	Shank	Segment	Image	UnitPack Qty	List Price(₹)
2608628461	Ø6.4xL16.2, S6	H-6 mm	Router Bit Flush Trim		1	333
2608629673	Ø6.35xL20xS8	H-8 mm	Router Bit Flush Trim Bit		1	550
2608629674	Ø12.7xL40xS8	H-8 mm	Router Bit Flush Trim Bit		1	895
2608629675	Ø19xL25.4xS8	H-8 mm	Router Bit Flush Trim Bit		1	830
2608629676	Ø12.7xL9.5xS8	H-8 mm	Router Bit Pattern bit		1	610
2608629677	Ø16xL25.4xS8	H-8 mm	Router Bit Pattern bit		1	790
2608629681	R1.6xØ15.9xL7.9xØS8	H-8 mm	Router Bit Rounding Over Bit		1	550
2608629678	Ø14xL30xS8	H-8 mm	Router Bit Straight Bit - extra length		1	720
2608629679	Ø16xL30xS8	H-8 mm	Router Bit Straight Bit - extra length		1	790
2608629680	90°xØ31.8xL20xS8	H-8 mm	Router Bit V-Groove Bit		1	799
2608628405	R3.2xØ9.5xL10.2xS8	H-8 mm	Router Bit Beading Bit		1	400
2608628356	R6.3xØ28.5xL13.2xS8	H-8 mm	Router Bit Cove Bit		1	670
2608628358	R9.5xØ35xL16.2xS8	H-8 mm	Router Bit Cove Bit		1	790
2608628393	R4.8xØ35xL14xS8	H-8 mm	Router Bit Edge Forming Bit		1	790
2608628394	R4xØ28.6xL12.4xS8	H-8 mm	Router Bit Edge Forming Bit		1	670

Part Number	Material Description	Shank	Segment	Image	UnitPack Qty	List Price(₹)
2608628395	R6.3xØ38.1xL17.1xS8	H-8 mm	Router Bit Edge Forming Bit		1	850
2608628396	R4.8xØ31.8xL14xS8	H-8 mm	Router Bit Edge Forming Bit		1	890
2608628397	R6.3xØ42.9xL17.7xS8	H-8 mm	Router Bit Edge Forming Bit		1	950
2608628398	R2.4xØ12.7xL12.4xS8	H-8 mm	Router Bit Edge Forming Bit		1	450
2608628357	R4.8xØ31.8xL12.4xS8	H-8 mm	Router Bit Ogee Fillet Bit		1	750
2608628359	R6.4xØ38xL15.7xS8	H-8 mm	Router Bit Roman Ogee Bit		1	890
2608628352	45°xØ35xL14.7xS8	H-8 mm	Router Bit Chamfer Bit		1	670
2608628367	R4xØ8xL9.2xS8	H-8 mm	Router Bit Core Box Bit		1	420
2608628368	R6xØ12xL9.2xS8	H-8 mm	Router Bit Core Box Bit		1	450
2608628369	R8xØ16xL12.4xS8	H-8 mm	Router Bit Core Box Bit		1	480
2608628346	Ø9.5xL25.4xS8	H-8 mm	Router Bit Flush Trim Bit		1	480
2608628347	Ø12.7xL13xS8	H-8 mm	Router Bit Flush Trim Bit		1	510
2608628348	Ø12.7xL25.4xS8	H-8 mm	Router Bit Flush Trim Bit		1	560
2608628350	Ø31.8xL12.5xS8	H-8 mm	Router Bit Rabbeting Bit		1	690
2608628339	R4xØ20.7xL10.2xS8	H-8 mm	Router Bit Rounding Over Bit		1	650
2608628340	R6xØ24.7xL13.2xS8	H-8 mm	Router Bit Rounding Over Bit		1	650
2608628341	R8xØ28.7xL15.2xS8	H-8 mm	Router Bit Rounding Over Bit		1	650
2608628342	R10xØ32.7xL16.2xS8	H-8 mm	Router Bit Rounding Over Bit		1	750
2608628343	R12xØ36.7xL18.6xS8	H-8 mm	Router Bit Rounding Over Bit		1	790
2608628344	R3xØ18.7xL10.2xS8	H-8 mm	Router Bit Rounding Over Bit		1	590
2608628402	Ø32xL4xS8	H-8 mm	Router Bit Slotting Cutter		1	850
2608628376	Ø3xL8xS8	H-8 mm	Router Bit Straight Bit		1	300
2608628377	Ø4xL8xS8	H-8 mm	Router Bit Straight Bit		1	350
2608628378	Ø5xL12.7xS8	H-8 mm	Router Bit Straight Bit		1	350
2608628379	Ø6xL15.7xS8	H-8 mm	Router Bit Straight Bit		1	350
2608628380	Ø7xL19.6xS8	H-8 mm	Router Bit Straight Bit		1	400
2608628381	Ø8xL19.6xS8	H-8 mm	Router Bit Straight Bit		1	400
2608628382	Ø9xL19.6xS8	H-8 mm	Router Bit Straight Bit		1	400
2608628383	Ø10xL19.6xS8	H-8 mm	Router Bit Straight Bit		1	400
2608628384	Ø11xL19.6xS8	H-8 mm	Router Bit Straight Bit		1	490
2608628385	Ø12xL19.6xS8	H-8 mm	Router Bit Straight Bit		1	420
2608628386	Ø13xL19.6xS8	H-8 mm	Router Bit Straight Bit		1	430
2608628375	Ø14xL19.6xS8	H-8 mm	Router Bit Straight Bit		1	500
2608628387	Ø15xL19.6xS8	H-8 mm	Router Bit Straight Bit		1	450
2608628388	Ø16xL19.6xS8	H-8 mm	Router Bit Straight Bit		1	450
2608628389	Ø18xL24.6xS8	H-8 mm	Router Bit Straight Bit		1	470
2608628390	Ø20xL24.6xS8	H-8 mm	Router Bit Straight Bit		1	510
2608628391	Ø22xL24.6xS8	H-8 mm	Router Bit Straight Bit		1	550
2608628392	Ø25xL19.6xS8	H-8 mm	Router Bit Straight Bit		1	550
2608628372	Ø8xL25xS8	H-8 mm	Router Bit Straight Bit		1	390
2608628373	Ø10xL25xS8	H-8 mm	Router Bit Straight Bit		1	450
2608628374	Ø12xL31.5xS8	H-8 mm	Router Bit Straight Bit		1	460
2608628406	60°xØ11xL13.7xS8	H-8 mm	Router Bit V-Groove Bit		1	360
2608628407	90°xØ16xL15.7xS8	H-8 mm	Router Bit V-Groove Bit		1	380

Part Number	Material Description	Shank	Segment	Image	UnitPack Qty	List Price(₹)
2608629692	Ø1/2"xL1"xS1/4	H-1/4 inch	Router Bit Flush Trim Bit		1	660
2608629686	Ø5/8"xL1"xS1/4	H-1/4 inch	Router Bit Pattern bit		1	790
2608629690	R1/16"xØ5/8xL1/16"xS1/4	H-1/4 inch	Router Bit Rounding Over Bit		1	550
2608629691	R1/8"xØ3/4xL1/8xS1/4	H-1/4 inch	Router Bit Rounding Over Bit		1	590
2608629687	Ø1-1/4"xL1/4"xS1/4	H-1/4 inch	Router Bit Slotting Cutter		1	770
2608628420	R1/4"xØ1"xL1/2"xS1/4"	H-1/4 inch	Router Bit Cove Bit		1	550
2608628424	R1/4"xØ1"xL35/64"xS1/4"	H-1/4 inch	Router Bit Ovolo Bit		1	600
2608628416	45°xØ1 3/8"xL37/64"xS1/4"	H-1/4 inch	Router Bit Chamfer Bit		1	650
2608628418	R1/4"xØ1/2"xL23/64"xS1/4"	H-1/4 inch	Router Bit Core Box Bit		1	370
2608628425	R1/8"xØ1/4"xL23/64"xS1/4"	H-1/4 inch	Router Bit Core Box Bit		1	310
2608628635	Ø1/4"xL21/32"xS1/4"	H-1/4 inch	Router Bit Flush Trim Bit		1	450
2608628421	R1/4"xØ1"xL33/64"xS1/4"	H-1/4 inch	Router Bit Rounding Over Bit		1	650
2608628422	R3/8"xØ1 1/4"xL41/64"xS1/4"	H-1/4 inch	Router Bit Rounding Over Bit		1	670
2608628411	Ø1/4"xL5/8"xS1/4"	H-1/4 inch	Router Bit Straight Bit		1	360
2608628413	Ø1/2"xL49/64"xS1/4"	H-1/4 inch	Router Bit Straight Bit		1	450
2608628429	Ø5/16"xL49/64"xS1/4"	H-1/4 inch	Router Bit Straight Bit		1	350
2608628415	90°xØ1/2"xL31/64"xS1/4"	H-1/4 inch	Router Bit V-Groove Bit		1	350



PLANER KNIVES



ACCESSORIES FOR PLANERS Carbide Reversible Planer Knife



Part Number	Description	Unit Pack Qty	List Price (₹)
-------------	-------------	---------------	----------------

2607000096	Planer blade straight, tungsten carbide, 40° length x width: 82.4 x 5.5 mm (two Price)	2	692
------------	--	---	-----



2607001292	Planer blade straight, tungsten carbide, 40° length x width: 82.4 x 5.5 mm (ten Price)	10	2,978
------------	--	----	-------



FREEHAND ROUTER BITS



Part Number	Diameter mm	Unit Pack Qty	List Price (₹)
1609200314	13	1	636

ACCESSORIES FOR PLANERS Conventional HSS Planer Knife



Part Number	Description	Unit Pack Qty	List Price (₹)
-------------	-------------	---------------	----------------

2607000193	Planer blade High Speed Steel, 40° length x width: 82 x 29 mm	2	1,639
------------	---	---	-------



NEW!

TUNGSTEN CARBIDE PLANER KNIVES AND ADAPTOR SET



Part Number	Description	Unit Pack Qty	List Price (₹)
-------------	-------------	---------------	----------------

2608838999	Tungsten Carbide Planer Knives and Adaptor set	1	892
------------	--	---	-----

COATED ABRASIVES



COLOUR FOAM ABRASIVE

Highest quality in class



Colour Foam Product Specification



Foam colour	Grade	Sponge block soft	Sponge block soft	Sponge flex
Orange	Medium			
Yellow	Fine			
Green	Superfine			

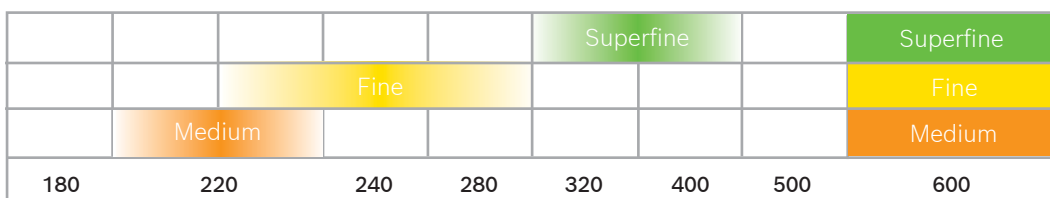

QUALITY HIT, BUDGET FIT

R420 5" Eco Fibre Sanding Disc

The best your tool can get. Bosch Professional Accessories.

Now Available in Vacuum Shrink Wrap Packaging



5" ALOX FLAP DISC ECO RANGE X-430

NEW!

Part Number	Mat. Description	List Price (₹)
2608619920	Flap Disc X430, G36, 5"ANSI, 1x	55
2608619921	Flap Disc X430, G40, 5"ANSI, 1x	55
2608619922	Flap Disc X430, G60, 5"ANSI, 1x	55
2608619923	Flap Disc X430, G80, 5"ANSI, 1x	55
2608619924	Flap Disc X430, G120, 5"ANSI, 1x	55



HOOK AND LOOP SANDING SHEETS FOR RANDOM ORBITAL SANDER, 8 HOLES

Part Number	Sheet Dimensions mm	Grit	Unit Pack Qty	List Price (₹)
2608601652	125	60	50	16
2608601653	125	80	50	16
2608601654	125	100	50	16
2608601655	125	120	50	16
2608601656	125	150	50	17
2608601657	125	180	50	18
2608601658	125	220	50	16
2608601659	125	240	50	15
2608601660	125	280	50	15
2608601661	125	320	50	16
2608601662	125	400	50	16
2608601663	125	500	50	17
2608601664	125	600	50	16

HOOK AND LOOP SANDING SHEETS FOR RANDOM ORBITAL SANDER, 6 HOLES

Part Number	Sheet Dimensions mm	Grit	Unit Pack Qty	List Price (₹)
2608601638	150	60	50	18
2608601639	150	80	50	18
2608601640	150	100	50	18
2608601641	150	120	50	18
2608601642	150	150	50	18
2608601643	150	180	50	18
2608601644	150	220	50	18
2608601645	150	240	50	18
2608601646	150	280	50	18
2608601647	150	320	50	18
2608601648	150	400	50	18
2608601649	150	500	50	18
2608601650	150	600	50	18

HOOK AND LOOP SANDING SHEETS FOR RANDOM ORBITAL SANDER, 8 HOLES
NEW!

Part Number	Sheet Dimensions mm	Grit	Unit Pack Qty	List Price (₹)
2608623135	230	120	10	459
2608623137	230	180	10	459
2608623138	230	220	10	459

HOOK AND LOOP SANDING SHEETS FOR RANDOM ORBITAL SANDER, 6 HOLES
NEW!

Part Number	Sheet Dimensions mm	Grit	Unit Pack Qty	List Price (₹)
2608623105	125	40	50	950
2608623106	125	60	50	918
2608623107	125	80	50	901
2608623108	125	120	50	901
2608623110	125	180	50	901
2608623111	125	220	50	901
2608623113	125	320	50	901
2608623114	150	40	50	1,114
2608623115	150	60	50	1,081
2608623116	150	80	50	1,049
2608623117	150	120	50	1,049
2608623119	150	180	50	1,049
2608623120	150	220	50	1,049
2608623122	150	320	50	1,049
2608623124	180	60	10	341
2608623125	180	80	10	341
2608623126	180	120	10	341
2608623127	180	150	10	341
2608623128	180	180	10	341
2608623129	180	220	10	341

HOOK AND LOOP SANDING SHEETS FOR RANDOM ORBITAL SANDER, 8 HOLES

Part Number	Sheet Dimensions mm	Grit	Unit Pack Qty	List Price (₹)
2608607491	125	40	50	1,954
2608607492	125	60	50	1,492
2608607493	125	80	50	1,324
2608607494	125	120	50	1,303
2608607495	125	180	50	1,326
2608607496	125	240	50	1,658
2608607497	125	320	50	1,544

HOOK AND LOOP SANDING SHEETS FOR RANDOM ORBITAL SANDER, 6 HOLES

Part Number	Sheet Dimensions mm	Grit	Unit Pack Qty	List Price (₹)
2608607498	150	40	50	1,993
2608607499	150	60	50	1,727
2608607500	150	80	50	1,622
2608607501	150	120	50	1,594
2608607502	150	180	50	1,551
2608607503	150	240	50	1,672
2608607504	150	320	50	1,788

**SANDING PADS FOR
BOSCH RANDOM ORBIT
SANDERS**

Part Number	Description	Diameter mm	Unit Pack Qty	List Price(₹)
2608000349	Sanding pad, Appropriate for Bosch GEX 125-1 AE Professional	125	1	1,055
2608601115	Sanding pad, Appropriate for Bosch GEX 150 AC; GEX 150 Turbo Professional	150	1	1,379
2608601062	Sanding pad, Appropriate for Bosch PEX 12; PEX 12 A; PEX 125; PEX 400 A; PEX 400 AE	125	1	811
2608601173	Sanding pad, Appropriate for Bosch GEX 270 A; GEX 270 AE Professional	125	1	1,389
2608601051	Sanding pad, Appropriate for Bosch GEX 150 AC Professional; PEX 15 AE, Soft	150	1	1,001
2608601052	Sanding pad, Appropriate for Bosch GEX 150 AC Professional; PEX 15 AE, Medium-hard	150	1	968
2608601053	Sanding pad, Appropriate for Bosch GEX 150 AC Professional; PEX 15 AE, Hard	150	1	978
2608601114	Sanding pad, Appropriate for Bosch GEX 125-150 AVE; GEX 150 AC; GEX 150 Turbo Professional, Extra-soft	150	1	1,408
2608900007	Backing Pad 150 mm Medium 	150	1	2,326

**X430
ECO FOR FLAP DISC**

Part Number	Disc Diameter mm	Grit	Unit Pack Qty	List Price(₹)
2608621838	100	36	10	32
2608621839	100	60	10	32
2608621840	100	80	10	32
2608621841	100	120	10	32
2608619920	125	36	10	57
New! 2608619921	125	40	10	55
New! 2608619922	125	60	10	55
New! 2608619923	125	80	10	55
New! 2608619924	125	120	10	55
New! 2608626199	180	36	5	100
New! 2608626200	180	60	5	105
New! 2608626201	180	80	5	100
New! 2608626202	180	120	5	100

**CERAMIC FIBRE
SANDING DISC**

Part Number	Disc Diameter mm	Grit	Unit Pack Qty	List Price(₹)
2608621610	125	36	1	74
2608621611	125	50	1	55
2608621612	125	60	1	55
2608621613	125	80	1	61
2608621614	125	100	1	46
2608621615	125	125	1	46

**X433
FLAP DISC
Bore Diameter 22.33 mm**

Part Number	Disc Diameter mm	Grit	Unit Pack Qty	List Price(₹)
2608619333	100	36	11	393
2608619334	100	60	11	393
2608619335	100	80	11	393
2608619336	100	120	11	393
2608619347	125	36	11	759
2608619348	125	40	11	759
2608619349	125	60	11	759
2608619350	125	80	11	759
2608619351	125	120	11	759
2608601684	180	40	10	150
2608601685	180	60	10	155
2608601686	180	80	10	155
2608601687	180	120	10	155

**X571/X551
FIBRE SANDING DISCS**

Part Number	Description	Disc Dia mm	Grit	Pack Qty	List Price(₹)
2608619323	4" x 571- 60#	100	60	1	113
2608607326	5" x 571- 40#. 1x	125	40	1	153
2608607365	5" x 551- 40#. 1x	125	40	1	209
2608607366	5" x 551- 60#. 1x	125	60	1	176

**FIBRE SANDING
DISCS**

Part Number	Sheet Dimensions mm	Grit	Unit Pack Qty	List Price(₹)
2608608P74	100	24	1	64
2608608P75	100	36	1	55
2608608P76	100	60	1	43
2608608P77	100	80	1	45
2608608P78	100	120	1	44
2608608P79	125	24	1	80
2608608P80	125	36	1	68
2608608P81	125	60	1	55
2608608P82	125	80	1	56
2608608P83	125	120	1	59
2608608P84	180	24	1	125
2608608P85	180	36	1	102
2608608P86	180	60	1	98
2608608P87	180	80	1	93
2608608P88	180	120	1	98

R574
**ZIRCONIA FIBRE
SANDING DISCS**



Part Number	Disc Diameter mm	Grit	Unit Pack Qty	List Price(₹)
2608607255	125	36	25	38
2608606731	125	24	25	42
2608606733	125	60	25	32
2608606734	125	80	25	32
2608606735	125	100	25	32
2608606736	125	120	25	32
2608607256	180	36	25	72
2608606742	180	60	25	58
2608606743	180	80	25	55
2608606744	180	100	25	55
2608606745	180	120	25	55

FIBRE SANDING DISC
Expert for Wood



Part Number	Sheet Dimensions mm	Grit	Unit Pack Qty	List Price(₹)
2608601577	100	24	25	26
2608601578	100	36	25	36
2608601579	100	40	25	21
2608601580	100	60	25	29
2608601581	100	80	25	28
2608601582	100	100	25	19
2608601583	100	120	25	27
2608601584	125	24	25	40
2608601585	125	36	25	39
2608601586	125	40	25	23
2608601587	125	60	25	30
2608601588	125	80	25	28
2608601589	125	100	25	28
2608601590	125	120	25	28
2608601591	180	24	25	77
2608601592	180	36	25	68
2608601593	180	40	25	50
2608601594	180	60	25	63
2608601595	180	80	25	58
2608601596	180	100	25	47
2608601597	180	120	25	57

R575
**ZIRCONIA FIBRE SANDING
DISCS**



Part Number	Disc Diameter mm	Grit	Unit Pack Qty	List Price(₹)
2608608P74	100	24	10	64
2608608P75	100	36	10	55
2608608P76	100	60	10	43
2608608P77	100	80	10	45
2608608P78	100	120	10	44
2608608P79	125	24	10	80
2608608P80	125	36	10	68
2608608P81	125	60	10	55
2608608P82	125	80	10	56
2608608P83	125	120	10	59
2608608P84	180	24	10	125
2608608P85	180	36	10	102
2608608P86	180	60	10	98
2608608P87	180	80	10	93
2608608P88	180	120	10	98

BOSCH NET



Part Number	Disc Diameter mm	Grit	Unit Pack Qty	List Price(₹)
2608621153	125	80	50	1,732
2608621154	125	100	50	1,732
2608621155	125	120	50	1,732
2608621156	125	150	50	1,732
2608621157	125	180	50	1,732
2608621158	125	220	50	1,587
2608621159	125	240	50	1,587
2608621160	125	320	50	1,587
2608621161	125	400	50	1,587
2608621171	150	80	50	2,886
2608621172	150	100	50	2,886
2608621173	150	120	50	2,886
2608621174	150	150	50	2,886
2608621175	150	180	50	2,742
2608621176	150	220	50	2,742
2608621177	150	240	50	2,742
2608621178	150	320	50	2,742
2608621179	150	400	50	2,598

4" CLEAN & STRIP DISC				
Part Number	Disc Diameter mm	Thickness mm	Unit Pack Qty	List Price(₹)

2608619286 100 16 5 254

PRESSURE SENSITIVE ADHESIVE DISCS				
NEW!				

Part Number	Disc Diameter mm	Grit	Unit Pack Qty	List Price(₹)
2608619798	125	80	50	527
2608619799	125	120	50	527
2608619801	125	220	100	1,049
2608619802	125	320	100	1,049

BACKING PADS FOR FIBRE SANDING DISCS INCLUDING NUT			
Part Number	Diameter mm	Unit Pack Qty	List Price(₹)

2608601046	100	1	399
2608601005	115	1	540
1608601033	125	1	576
2608601118	125	1	1,022
1603345004	180	1	260
1608601006	180	1	804
2608601209	180	1	776

LAMBSWOOL BONNET FOR POLISHERS				
Part Number	Description	Diameter mm	Unit Pack Qty	List Price(₹)

1608610000	Lambswool Bonnet, Appropriate for GPO 12; GPO 12 E Professional	180	1	979
1608613013	Polishing Sponge, Appropriate for GPO 12; GPO 12 E Professional	180	1	1,902

LAMBSWOOL BONNET FOR RANDOM ORBIT SANDERS				
Part Number	Description	Diameter mm	Unit Pack Qty	List Price(₹)

2608610001	Polishing Cap, Appropriate for all conventional brands of machines	130	1	322
3608610000	Polishing Cap, Appropriate for all conventional brands of machines	160	1	990
2608621759	100% twisted wool	-	1	730

CERAMIC FIBRE SANDING DISC			
Part Number	Description	Unit Pack Qty	List Price(₹)

2608621614	Ceramic Fibre Sanding disc, BfM+I, 125mm, Grit 100	1	46
2608621615	Ceramic Fibre Sanding disc, BfM+I, 125mm, Grit 120	1	46
2608621610	Ceramic Fibre Sanding disc, BfM+I, 125mm, Grit 36	1	74
2608621611	Ceramic Fibre Sanding disc, BfM+I, 125mm, Grit 50	1	55
2608621612	Ceramic Fibre Sanding disc, BfM+I, 125mm, Grit 60	1	55
2608621613	Ceramic Fibre Sanding disc, BfM+I, 125mm, Grit 80	1	61

FOAM BLOCK			
NEW!			

Part Number	Description	Unit Pack Qty	List Price(₹)
2608901169	69x97x26 mm, Grit-Medium	50	44
2608901170	69x97x26 mm, Grit-Fine	50	44
2608901180	69x97x26 mm, Grit-Super Fine	50	44

FOAM PAD			
NEW!			

Part Number	Description	Unit Pack Qty	List Price(₹)
2608901171	98x120x13 mm, Grit-Medium	50	30
2608901172	98x120x13 mm, Grit-Fine	50	30
2608901173	98x120x13 mm, Grit-Super Fine	50	30

HAND SANDING SHEET WOOD & WALL			
*Available till stocks last			

Part Number	Description	Unit Pack Qty	List Price(₹)
2608621491	230x280 mm, Grit 60	100	992
2608621492	230x280 mm, Grit 80	100	992
2608621493	230x280 mm, Grit 100	100	928
2608621494	230x280 mm, Grit 120	100	928
2608621495	230x280 mm, Grit 150	100	928
2608621496	230x280 mm, Grit 180	100	928
2608621497	230x280 mm, Grit 220	100	928
2608621498	230x280 mm, Grit 240	100	928
2608621499	230x280 mm, Grit 320	100	928

**POLISHING SPONGES FOR
RANDOM ORBIT SANDERS**

Part Number	Description	Diameter mm	Unit Pack Qty	List Price(₹)
2608613005	Polishing Cap, Appropriate for all conventional brands of machines	130	1	360

**POLISHING FELTS FOR
RANDOM ORBIT SANDERS**

Part Number	Description	Diameter mm	Unit Pack Qty	List Price(₹)
3608604000	Polishing Cap, Appropriate for all conventional brands of machines	160	1	1,347

**CERAMIC FIBRE
SANDING DISC**

Part Number	Description	Unit Pack Qty	List Price(₹)
2608621614	Ceramic Fibre Sanding disc, BfM+I, 125mm, Grit 100	1	46
2608621615	Ceramic Fibre Sanding disc, BfM+I, 125mm, Grit 120	1	46
2608621610	Ceramic Fibre Sanding disc, BfM+I, 125mm, Grit 36	1	74
2608621611	Ceramic Fibre Sanding disc, BfM+I, 125mm, Grit 50	1	55
2608621612	Ceramic Fibre Sanding disc, BfM+I, 125mm, Grit 60	1	55
2608621613	Ceramic Fibre Sanding disc, BfM+I, 125mm, Grit 80	1	61

**HAND SANDING SHEET
GENERAL PURPOSE**
*Available till stocks last



Part Number	Description	Unit Pack Qty	List Price(₹)
2608621106	230x280 mm, Grit 60	100	1,618
2608621107	230x280 mm, Grit 80	100	1,596
2608621108	230x280 mm, Grit 100	100	1,573
2608621109	230x280 mm, Grit 120	100	1,587
2608621110	230x280 mm, Grit 150	100	1,593
2608621111	230x280 mm, Grit 180	100	1,604
2608621112	230x280 mm, Grit 220	100	1,591
2608621113	230x280 mm, Grit 240	100	1,593
2608621114	230x280 mm, Grit 320	100	1,598
2608621115	230x280 mm, Grit 400	100	1,596
2608621116	230x280 mm, Grit 500	100	1,606
2608621117	230x280 mm, Grit 600	100	1,607
2608621118	230x280 mm, Grit 800	100	1,610
2608621119	230x280 mm, Grit 1000	100	1,610
2608621120	243x280 mm, Grit 1200	100	1,611

**ABRASIVE WEB AND
NON WOVEN ABRASIVES**

Part Number	Description	Unit Pack Qty	List Price(₹)
F03E014K8K	MA Roll 150mm x 20m	1	4,014
F03E014K8H	VFA XS Roll150mmx20m	1	2,721
F03E014K8J	MA HP 152mm x 229mm	1	48
F03E014K8G	VFA XS HP 152x229mm	1	31



HAND SANDING SHEET AUTOMOTIVE			
Part Number	Description	Unit Pack Qty	List Price(₹)
2608621509	230x280 mm, Grit 60	100	1,734
2608621510	230x280 mm, Grit 80	100	1,734
2608621511	230x280 mm, Grit 100	100	1,734
2608621512	230x280 mm, Grit 120	100	1,734
2608621513	230x280 mm, Grit 150	100	1,754
2608621514	230x280 mm, Grit 180	100	1,754
2608621515	230x280 mm, Grit 220	100	1,754
2608621516	230x280 mm, Grit 240	100	1,754
2608621517	230x280 mm, Grit 320	100	1,754
2608621518	230x280 mm, Grit 400	100	1,754
2608621519	230x280 mm, Grit 500	100	1,754
2608621520	230x280 mm, Grit 600	100	1,754
2608621521	230x280 mm, Grit 800	100	1,812
2608621522	230x280 mm, Grit 1000	100	1,812
2608621523	230x280 mm, Grit 1200	100	1,812
2608621524	230x280 mm, Grit 1500	100	1,812
2608621525	230x280 mm, Grit 2000	100	1,744
2608621526	230x280 mm, Grit 2500	100	1,802

NEW ROLLS SIA 2906 FLEXIBLE			
Part Number	Description	Unit Pack Qty	List Price(₹)
F03E02G1FK	102x50 mm, Grit 60	1	1,759
F03E02G18W	102x50 mm, Grit 80	1	1,758
F03E02G18X	102x50 mm, Grit 100	1	1,759
F03E02G18Y	102x50 mm, Grit 120	1	1,759
F03E02G1FL	102x50 mm, Grit 180	1	1,759
F03E02G1FM	102x50 mm, Grit 220	1	1,759
F03E02G1FN	102x50 mm, Grit 320	1	1,889

NEW ROLLS SIA 2909 RIGID			
Part Number	Description	Unit Pack Qty	List Price(₹)
F03E02G1FP	102x50 mm, Grit 36	1	1,759
F03E02G1FR	102x50 mm, Grit 40	1	1,759
F03E02G1FS	102x50 mm, Grit 60	1	1,759
F03E02G199	102x50 mm, Grit 80	1	1,759
F03E02G1FT	102x50 mm, Grit 100	1	1,759
F03E02G19A	102x50 mm, Grit 120	1	1,759
F03E02G19C	102x50 mm, Grit 180	1	1,889
F03E02G1FU	102x50 mm, Grit 220	1	1,759
F03E02G1FV	102x50 mm, Grit 320	1	1,759

NARROW BELT X540		NEW!			
Part Number	Size	Grit	Unit Pack Qty	List Price(₹)	
2608623389	50x2000 mm	36	15	2,625	
2608623390	50x2000 mm	60	15	2,625	
2608623391	50x2000 mm	80	15	2,625	
2608623392	50x2000 mm	120	15	2,625	



CUTTING AND GRINDING

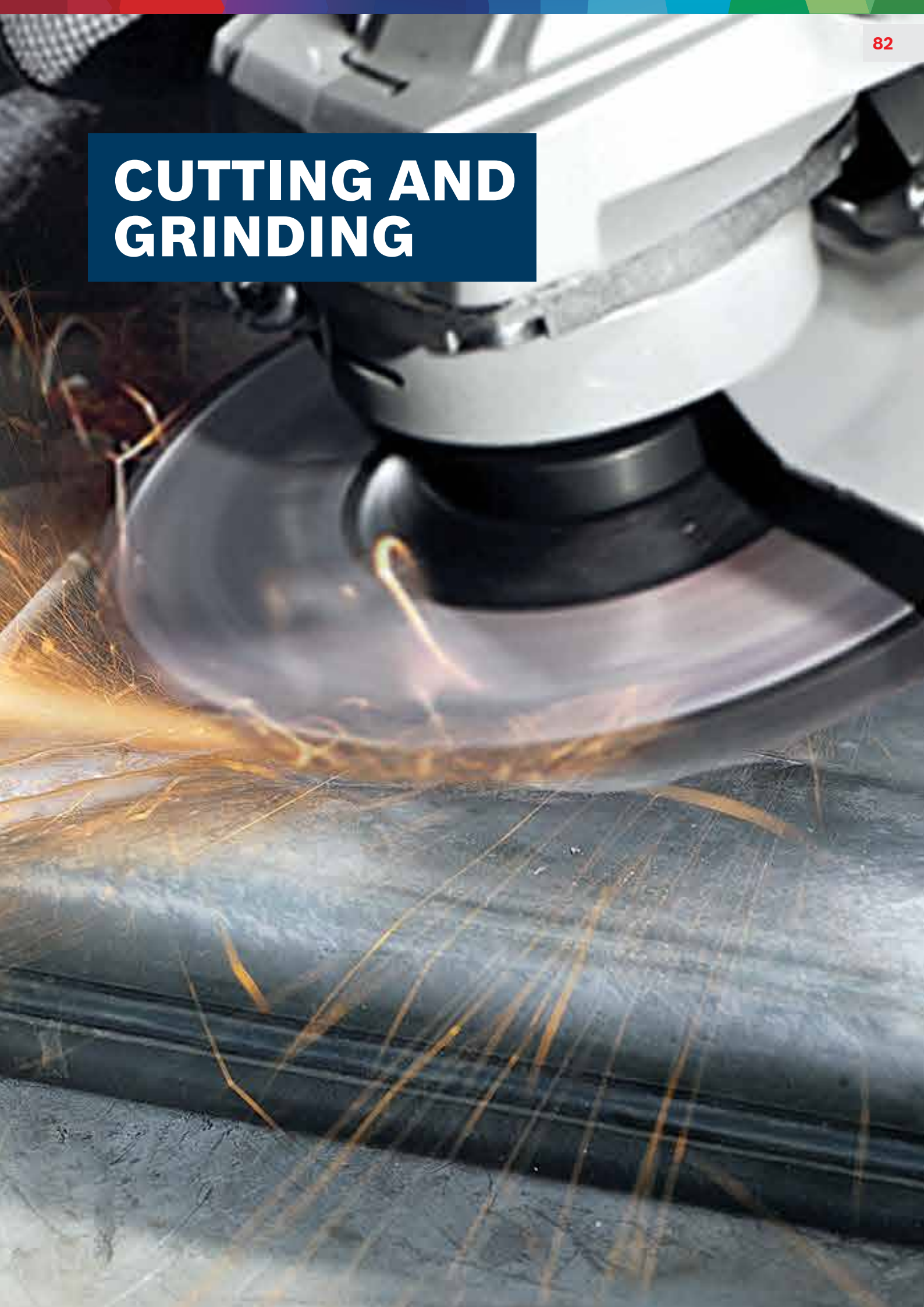

JUST ONE CLICK

X-LOCK. The ultimate changing system for grinders

X-LOCK

PRO

NEW!



Part Number	Description	UnitPack Qty	List Price(₹)
2608619366	X-LOCK Standard for Metal 125x6x22.23 mm Depressed Grinding	1	47
2608619262	X-LOCK Standard for Metal 125x1x22.23 mm Straight Cutting	1	78
2608619264	X-LOCK Expert for Inox & Metal 125x1x22.23 mm Straight Cutting	1	99
2608619265	X-LOCK Expert for Inox 125x1.6x22.23 mm Straight Cutting	1	323
2608620730	X-LOCK Cup brush Crimped 75 mm Brass coated 0.3mm	1	849
2608601716	X-LOCK Backing Pad 125 mm hard	1	225
2608601720	X-LOCK CLIP	1	77
2608619183	X-LOCK Fibre Disc, 125 mm, G36, FSD-Ceramic (MS & INOX)	1	57
2608619185	X-LOCK Fibre Disc, 125 mm, G60, FSD-Ceramic (MS & INOX)	1	44
2608619172	X-LOCK Fibre sanding discs, Ø125 mm, G 36, FSD-Alox (MS & Wood)	1	94
2608619173	X-LOCK Fibre sanding discs, Ø125 mm, G 60, FSD-Alox (MS & Wood)	1	28
2608619174	X-LOCK Fibre sanding discs, Ø125 mm, G 80, FSD-Alox (MS & Wood)	1	33
2608619176	X-LOCK Fibre sanding discs, Ø125 mm, G 120, FSD-Alox (MS & Wood)	1	33
2608619284	X-LOCK 125 mm, Carbide Multi wheel	1	567

STANDARD FOR METAL THIN CUTTING DISCS 180 mm/7 inch





NEW!

Part Number	Description	Dimension mm	Thickness mm	Unit Pack Qty	List Price(₹)
2608619384	Standard for Metal Cutting Disc - 180 mm	180	1.6	25	65

DIAMOND METAL CUTTING WHEEL				
EXPERT				
Part Number	Diameter mm	Bore Size mm	Unit Pack Qty	List Price(₹)
2608900531	105	20/16	1	1,063
2608900533 (X-lock)	125	22.23	1	1,418
2608900535	180	22.23	1	2,765
2608900537	355	25.4	1	9,216

CUTTING DISCS Best for Metal				
Part Number	Diameter mm	Thickness mm	Unit Pack Qty	List Price(₹)
2608620674	100	1.2	50	57
2608620676	125	3	50	67
2608620677	180	3	50	97

CUTTING DISCS Standard for Metal				
Part Number	Diameter mm	Thickness mm	Unit Pack Qty	List Price(₹)
2608600663	100	1.2	50	57
2608600664	100	2.5	25	56
2608602745	100	2	25	33
New! 2608615275	105	1.2	25	19
New! 2608615276 (Green)	105	1.2	25	19
2608615279	105	1.2	25	19
2608600394	125	2.5	25	75
2608603165	125	1.2	25	40
2608603166	125	2.5	25	44
2608600665	125	3	25	73
2608619384	180	1.6	25	65
2608600666	180	3	25	95
2608600321	180	3	25	95
2608600667	230	3	25	162
2608619377	355	2.8	20	172
New! 2608619765 (Green)	355	2.8	20	157
2608619382	355	3	20	172
2608602751	355	3	20	178
2608601322	355	2.8	25	177
2608600936	355	3	25	276

ECO 125 MM CUTTING DISC RANGE Standard for INOX				
Part Number	Diameter mm	Thickness mm	Unit Pack Qty	List Price(₹)
2608603413	105	1	25	43
2608603171	125	1	25	38
2608603172	125	1.6	25	39
2608603462	125	1	50	78
2608600549	125	1	25	150
2608600094	125	2	25	155
2608603498	180	1.6	25	175
2608600095	180	2	25	178
2608600322	180	3	25	135
2608600096	230	3	25	256

EXPERT FOR HEAVY METAL IN CUTTING AND GRINDING				
Part Number	Diameter mm	Thickness mm	Unit Pack Qty	List Price(₹)
2608619394	355	3	25	186

GRINDING DISCS Best for Metal				
Part Number	Diameter mm	Thickness mm	Unit Pack Qty	List Price(₹)
2608601323	100	6	25	57
2608603299	100	6	25	54
2608601324	125	6	25	93
2608603300	125	6	25	95
2608601325	180	6.7	25	122
2608603301	180	6.7	25	120
2608601326	230	6	25	203
2608603302	230	6	25	213

4" GRINDING DISC Expert for Metal Grinding				
Part Number	Diameter mm	Thickness mm	Unit Pack Qty	List Price(₹)
2608619379	100	4.5	25	37
2608603686	100	6	25	38

CUTTING DISC Expert for Inox				
Part Number	Diameter mm	Thickness mm	Unit Pack Qty	List Price(₹)
2608607414	105	1	1	75
2608600710	180	1.6	1	217

CUTTING DISC
 Expert for Metal

Part Number	Diameter mm	Thickness mm	Unit Pack Qty	List Price(₹)
2608601706	105	1.2	1	23

GRINDING DISCS
 Standard for Metal

Part Number	Diameter mm	Thickness mm	Unit Pack Qty	List Price(₹)
2608602748	100	4	20	31
2608603224	100	4	25	36
2608603227	125	6.8	20	81

GRINDING DISCS
 Expert for Metal

Part Number	Diameter mm	Thickness mm	Unit Pack Qty	List Price(₹)
2608602379	180	6.6	25	104

GRINDING DISCS
 Expert for Inox

Part Number	Diameter mm	Thickness mm	Unit Pack Qty	List Price(₹)
2608620690	100	2	1	69

EXPERT FOR V - GRINDING DISCS

Part Number	Diameter mm	Thickness mm	Unit Pack Qty	List Price(₹)
2608602374	180	5	25	100
2608602375	180	7	25	104

GRINDING DISCS - METAL

Part Number	Diameter mm	Thickness mm	Unit Pack Qty	List Price(₹)
2608602372	100	6	25	47
2608602373	180	6.6	25	102

GRINDING DISCS - INOX

Part Number	Diameter mm	Thickness mm	Unit Pack Qty	List Price(₹)
2608600539	115	6	10	151
2608600540	180	7	10	264
2608600541	230	6	10	354

GRINDING STONE, CYLINDRICAL, MEDIUM-HARD

Part Number	Image	Dia. mm	Grit	Dia. mm	Length mm	Unit Pack Qty	List Price(₹)
1608620055		6	60	25	20	1	179
1608620056		6	60	20	20	1	180
2608620012		6	60	20	26	1	113
2608620014		6	60	20	25	1	205
1609200286		6	60	25	35	5	676

BENCH GRINDING WHEEL

Part Number	Description	Bore mm	Unit Pack Qty	List Price(₹)
1609201649	150 mm 24 Grit Coarse	20	1	483
1609201650	150 mm 60 Grit Fine	20	1	483
2608600111	200 mm 36 Grit Medium	32	1	773
2608600112	200 mm 60 Grit Fine	32	1	765



WIRE WHEEL, BRASS-COATED						
Part Number	Diameter mm	Wire Thickness mm	Bore Size mm	Tool to be Used	Unit Pack Qty	List Price(₹)
2608622009	75	0.2	6	Rotary drill	1	432



WIRE CUP BRUSH Crimped Wire, Inox						
Part Number	Diameter mm	Wire Thickness mm	Bore Size mm	Tool to be Used	Unit Pack Qty	List Price(₹)
2608622061	65	0.3	M14	5/7 inch grinder	1	513



WIRE CUP BRUSH CRIMPED WIRE						
Part Number	Diameter mm	Wire Thickness mm	Bore Size mm	Tool to be Used	Unit Pack Qty	List Price(₹)
1608614011	100	0.5	M14	5/7 inch grinder	1	1,246



BRUSHING Pencil Brush						
Part Number	Diameter mm	Wire Thickness mm	Bore Size mm	Tool to be Used	Unit Pack Qty	List Price(₹)
1609200269	25	0.3	6	Shank rotary drill	1	360



WIRE CUP BRUSH Crimped Wire, Brass-coated with Thread						
Part Number	Diameter mm	Wire Thickness mm	Bore Size mm	Tool to be Used	Unit Pack Qty	List Price(₹)
2608622062	75	0.3	M10	4 inch grinder	1	781



BRUSHING Wire Wheel						
Part Number	Diameter mm	Wire Thickness mm	Bore Size mm	Tool to be Used	Unit Pack Qty	List Price(₹)
2608622007	75	0.3	6	Shank rotary drill	1	283



WIRE CUP BRUSH Crimped Wire, Brass-coated						
Part Number	Diameter mm	Wire Thickness mm	Bore Size mm	Tool to be Used	Unit Pack Qty	List Price(₹)
1608614020	70	0.3	M14	5/7 inch grinder	1	418



TAPERED BRUSHES For Angle Grinders Crimped Wire						
Part Number	Diameter mm	Wire Thickness mm	Bore Size mm	Tool to be Used	Unit Pack Qty	List Price(₹)
2608622057	100	0.3	M14	5/7 inch grinder	1	1,186



WIRE CUP BRUSH Knotted Wire						
Part Number	Diameter mm	Wire Thickness mm	Bore Size mm	Tool to be Used	Unit Pack Qty	List Price(₹)
1608622029	75	0.5	M14	5/7 inch grinder	1	869
1608614002	100	0.8	M14	5/7 inch grinder	1	1,825



TAPERED BRUSHES For Angle Grinders Knotted Wire						
Part Number	Diameter mm	Wire Thickness mm	Bore Size mm	Tool to be Used	Unit Pack Qty	List Price(₹)
2608622011	100	0.5	M14	5/7 inch grinder	1	1,290



WIRE CUP BRUSH Knotted Wire M10						
Part Number	Diameter mm	Wire Thickness mm	Bore Size mm	Tool to be Used	Unit Pack Qty	List Price(₹)
2608622063	75	0.5	M10	4 inch grinder	1	1,417



WIRE CUP BRUSH For Angle Grinders Knotted Wire, Stainless						
Part Number	Diameter mm	Wire Thickness mm	Bore Size mm	Tool to be Used	Unit Pack Qty	List Price(₹)
2608622060	75	0.5	M14	5/7 inch grinder	1	1,969



SCREWDRIVING BITS



DOUBLE ENDED BITS



Part Number	Screw Type	Working Length mm	Colour	Unit Pack Qty	List Price(₹)
2608521038	PH2	45	Grey	10	468
2608521039	PH2	65	Grey	10	478
2608521040	PH2	110	Grey	10	780
2608521041	PH2	45	Gold	10	418
2608521042	PH2	65	Gold	10	409
2608521043	PH2	110	Gold	10	1,021

DOUBLE ENDED BITS

NEW!



Part Number	Image	Screw Type	Working Length mm	Colour	Unit Pack Qty	List Price(₹)
-------------	-------	------------	-------------------	--------	---------------	---------------







2608522371  PH2 65 Grey 100 3,6122608522372  PH2 65 Gold 100 3,201STANDARD FOR UNIVERSAL
DOUBLE ENDED SCREWDRIVER
BITS PH2/SL6

Part Number	Length mm	Unit Pack Qty	List Price(₹)
2608522265	65	10	424
2608522266	110	10	570

IMPACT DOUBLE ENDED
SCREWDRIVING BITS

NEW!



Part Number	Image	Description	Unit Pack Qty	List Price(₹)
-------------	-------	-------------	---------------	---------------







2608522405  Expert for Impact 6.35x65 mm, Black Oxide, PH2 double-ended 10 8972608522406  Expert for Impact 6.35x110 mm, Black Oxide, PH2 double-ended 10 1,4532608522407  Expert for Impact 6.35x150 mm, Black Oxide, PH2 double-ended 5 1,2132608522408  Expert for impact 6.35x65 mm Black Oxide PH2 Bits 2 2002608522409  Expert for impact 6.35x110 mm Black Oxide PH2 Bits 2 3262608522410  Expert for impact 6.35x150 mm Black Oxide PH2 Bits 2 496SOCKETS FOR IMPACT
WRENCHES

Part Number	Length of Socket mm	A/F Size	Square Drive inches	Unit Pack Qty	List Price(₹)
1608552000	30	7	3/8"	1	183
1608552001	30	8	3/8"	1	194
1608552003	30	10	3/8"	1	196
1608552005	30	12	3/8"	1	199
1608552006	30	13	3/8"	1	199
1608552008	30	15	3/8"	1	191
1608552009	30	16	3/8"	1	193
1608552010	30	17	3/8"	1	208
2608522301	30	19	3/8"	1	222
1608552012 New! 2608003043	38	10	1/2"	1	236
1608552013	38	11	1/2"	1	237
1608552015 New! 2608003046	38	13	1/2"	1	239
1608552019 New! 2608003048	38	17	1/2"	1	247
2608522307	38	21	1/2"	1	304
1608555024	38	22	1/2"	1	312
1608555053 New! 2608003054	38	24	1/2"	1	329
1608555059 New! 2608003056	38	27	1/2"	1	403
1608555065 New! 2608003057	38	30	1/2"	1	498
2608522302 New! 2608003044	77	10	1/2"	1	359
2608522303 New! 2608003045	77	11	1/2"	1	360
2608522304 New! 2608003047	77	13	1/2"	1	362
2608522305 New! 2608003049	77	17	1/2"	1	365
2608522306 New! 2608003051	77	19	1/2"	1	393
2608522308 New! 2608003052	77	21	1/2"	1	415
2608522309 New! 2608003053	77	22	1/2"	1	473
2608522310 New! 2608003055	77	24	1/2"	1	510
2608522311	77	27	1/2"	1	604
1608556005 New! 2608003058	50	19	3/4"	1	648
1608556011 New! 2608003059	50	22	3/4"	1	659
1608556015 New! 2608003060	51	24	3/4"	1	661
1608556021 New! 2608003061	52	27	3/4"	1	731
1608556027 New! 2608003062	54	30	3/4"	1	775
1608556029 New! 2608003063	56	32	3/4"	1	822

IMPACT SOCKET SETS PRO RANGE

Newly
Launched!

Part Number	Drive Size	Packaging	Socket type	Prices	Ref. picture	Diameter mm	Length mm	List Price(₹)
2608003032	1/2	Set	Standard sockets	7		13	38	1,857
						17	38	
						19	38	
						21	38	
						24	40	
						Wrench Adaptor ADP 1/2"		
2608003038	1/2	Fabric bag	Standard sockets	9		10	38	2,724
						11	38	
						13	38	
						17	38	
						19	38	
						21	38	
						22	38	
						24	40	
2608003039	1/2	Fabric bag	Deep sockets	9		10	77	3,469
						12	77	
						13	77	
						14	77	
						15	77	
						16	77	
						17	77	
						18	77	
2608003040	1/2	Fabric bag	Deep sockets	9		10	77	4,181
						11	77	
						13	77	
						17	77	
						19	77	
						21	77	
						22	77	
						24	77	
						27	77	

Part Number	Drive Size	Packaging	Socket type	Prices	Ref. picture	Diameter mm	Length mm	List Price(₹)
2608003034	1/4"	Fabric bag	Standard sockets	9		6	25	1,645
						7	25	
						8	25	
						9	25	
						10	25	
						11	25	
						12	25	
						13	25	
						14	25	
2608003035	1/4"	Fabric bag	Deep sockets	9		6	50	1,927
						7	50	
						8	50	
						9	50	
						10	50	
						11	50	
						12	50	
						13	50	
						14	50	
2608003036	3/8	Fabric bag	Standard sockets	9		7	28	2,036
						8	28	
						10	28	
						12	28	
						13	30	
						15	30	
						16	30	
						17	30	
						19	30	
2608003037	3/8"	Fabric bag	Deep sockets	9		7	60	2,501
						8	62	
						10	63	
						12	63	
						13	63	
						15	63	
						16	63	
						17	63	
						19	63	
2608003041	3/4"	Fabric bag	Standard sockets	9		17	51	7,284
						19	51	
						21	51	
						22	51	
						23	51	
						24	51	
						27	54	
						30	54	
						32	57	
2608003042	3/4"	Fabric bag	Deep sockets	9		17	90	10,585
						19	90	
						21	90	
						22	90	
						23	90	
						24	90	
						27	90	
						30	90	
32	90							

**SCREWDRIVER BITS
EXTRA HARD**

Part Number	Diameter mm	Working Length mm	Unit Pack Qty	List Price(₹)
2607001513	T27	49	25	1,525
2607001514	PH2	25	100	4,616
2607001526	PH1	49	3	514
2607001528	PH2	49	3	511
2607001531	PH3	49	3	461
2607001535	PH2	89	3	760
2607001540	PH2	152	1	580
2607001642	T30	49	1	177
2607001658	T30	89	1	316
2607001668	T20	152	1	540

**UNIVERSAL HOLDER WITH 1/4"
EXTERNAL HEXAGON SHANK**

Part Number	Drive End inches	Diameter mm	Key Width (KW) mm	Unit Pack Qty	List Price(₹)
2607000157	1/4"	75	11	1/40	631

HEXAGON SOCKET WRENCH

Part Number	Length mm	Diameter mm	Unit Pack Qty	List Price(₹)
1608552021	40	30	1	261
New! 2608003050				



HIGH SPEED DRILLING IN WOOD

EXPERT Self Cut Speed Spade Drill Bits

EXPERT

- ① Fast drilling is easy with Bosch Tip Technology.
- ② Self-feeding thread for effortless, high-speed drilling.
- ③ Clever wave-shaped spade designed for fast chip removal.







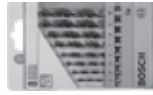

* vs. Bosch Spade Bit 2609255269



WOOD BIT SETS & ACCESSORIES

Part Number	Description	Unit Pack Qty	List Price(₹)
2607019440	5 Pc Wood Drill Bit Set	1	366
2608587520	Extension 1/4" Hex Quick Change 152 mm	1	820
2608587521	Extension 1/4" Hex Quick Change 305 mm	1	1,008
2608596977	Forstner bit set 35 mm, 90 mm, 10 mm	1	1,102
2609255308	Wood Drill Set 6, 8, 10 (3)	1	189

**WOOD DRILL BIT SETS
Self Cut Speed spade bit set**
EXPERT

NEW EXPERT Part Number	Image	Description	Unit Pack Qty	List Price(₹)
2608900331		3-Price Self Cut Speed Spade Bit Set 20/22/25 mm	3	814
2608900332		6-Price Self Cut Speed Spade Bit Set 14/16/18/20/22/24 mm	6	1,567
2608900333		6-Price Self Cut Speed Spade Bit Set 13/16/19/20/22/25 mm	6	1,499
2608900334		7-Price Self Cut Speed Spade Bit Set 16/18/20/22/25/32 mm+Extension (152 mm)	7	1,772
2608900335		8-Price Self Cut Speed Spade Bit Set 12/16/18/20/22/25/28/32 mm	8	2,181
2608900336		13-Price Self Cut Speed Spade Bit Set 10/12/13/14/16/18/20/22/24/25/28/30/32 mm	13	3,271

**WOOD SPADE BITS
Self Cut Speed**

NEW EXPERT Part Number	Diameter mm	Total Length mm	Unit Pack Qty	List Price(₹)
2608900309	6	152	1	217
2608900310	8	152	1	210
2608900311	10	152	1	200
2608900312	12	152	1	269
2608900313	13	152	1	276
2608900314	14	152	1	289
2608900315	16	152	1	316
2608900316	17	152	1	300
2608900317	18	152	1	314
2608900318	19	152	1	336
2608900319	20	152	1	349
2608900320	22	152	1	330
2608900321	24	152	1	315
2608900322	25	152	1	397
2608900323	26	152	1	315
2608900324	28	152	1	315
2608900325	30	152	1	315
2608900326	32	152	1	459
2608900327	35	152	1	429
2608900328	36	152	1	450
2608900329	38	152	1	429
2608900330	40	152	1	450
2608900337	6	400	1	409
2608900338	8	400	1	416
2608900339	10	400	1	422
2608900340	12	400	1	422
2608900341	13	400	1	422
2608900342	14	400	1	429
2608900343	16	400	1	436
2608900344	17	400	1	463
2608900345	18	400	1	470
2608900346	19	400	1	470
2608900347	20	400	1	504
2608900348	22	400	1	518
2608900349	24	400	1	559
2608900350	25	400	1	572
2608900351	26	400	1	681
2608900352	28	400	1	750
2608900353	30	400	1	777
2608900354	32	400	1	818
2608900355	35	400	1	886
2608900356	36	400	1	927
2608900357	38	400	1	1,022
2608900358	40	400	1	954

**BRAD POINT WOOD
DRILL BITS**

Part Number	Diameter mm	Total Length mm	Unit Pack Qty	List Price(₹)
2608596301	4	70	1	55
2608596302	5	85	1	68
2608596303	6	90	1	78
2608596305	8	117	1	129
2608596307	10	120	1	133

**WOOD SPADE BITS
Clean Cut Range**

Part Number	Diameter mm	Total Length mm	Unit Pack Qty	List Price(₹)
2608587496	6	155	1	91
2608587497	8	155	1	92
2608587498	10	155	1	103
2608587499	12	155	1	104
2608587500	13	155	1	109
2608587501	14	155	1	110
2608587502	16	160	1	117
2608587504	18	160	1	118
2608587505	19	160	1	129
2608587506	20	160	1	137
2608587507	22	160	1	149
2608587508	24	160	1	157
2608587509	25	160	1	164
2608587511	28	165	1	184
2608587512	30	165	1	193
2608587513	32	165	1	208
2608587514	35	165	1	264
2608587516	38	165	1	251

WOOD DRILLING

Part Number	NEW! Part Number	UnitPack Qty	List Price(₹)
2608595481	2608900309	1	217
2608595484	2608900312	1	269
2608595485	2608900313	1	276
2608595486	2608900314	1	289
2608595487	2608900315	1	316
2608595489	2608900317	1	315
2608595490	2608900318	1	336
2608595491	2608900319	1	350
2608595494	2608900322	1	397
2608595498	2608900326	1	459

*Available till stocks last





USE OF BRAD POINT BITS

- ▶ Suitable for hard and soft wood
- ▶ Drill bit with centring tip and shoulder cutter
- ▶ Drill bit colour: black, ground point
- ▶ Two flutes

METAL DRILL BITS



HSS Drill Bits – Range Overview

	HSS PointTeQ	HSS Ground	HSS Cobalt
			
Lifetime	● ○	● ●	● ● ●
Speed	● ● ●	● ● ●	● ● ●
Precision	● ●	● ● ●	● ● ●
Features	Fast Drilling in Metal	Highest-Precision Holes	Long Lifetime when Drilling Stainless Steel

	Plastic	Non-Alloy Steel	Non-Ferrous Metals	Cast Steel	Aluminium and Alloy Steel	Cast Iron	Stainless Steel
 HSS PointTeQ	●	●	●	●	○	○	–
 HSS Ground	●	●	●	●	●	○	–
 HSS Cobalt	○	○	●	●	●	●	●

● Recommended ○ Acceptable – Not Recommended



HSS PointTeQ

Fast Drilling in Metal

Increased lifetime

As a result of its fast drilling rate which leads to reduced wear

Fast chip removal

Supported by the black-oxide coated flute

Low risk of breakage

Due to drill bit body manufactured with high elasticity

Fast and easy start

The self-centering PointTeQ tip design allows an easy and efficient start



- ▶ HSS PointTeQ enables fast drilling in metal due to PointTeQ tip design.
- ▶ Self-centering tip prevents wandering, making quick and easy drilling starts possible.
- ▶ Increased drilling rate generates less heat and wear.
- ▶ PointTeQ tip design remains sharp and ensures continuous durability.
- ▶ Manufactured to DIN 338.

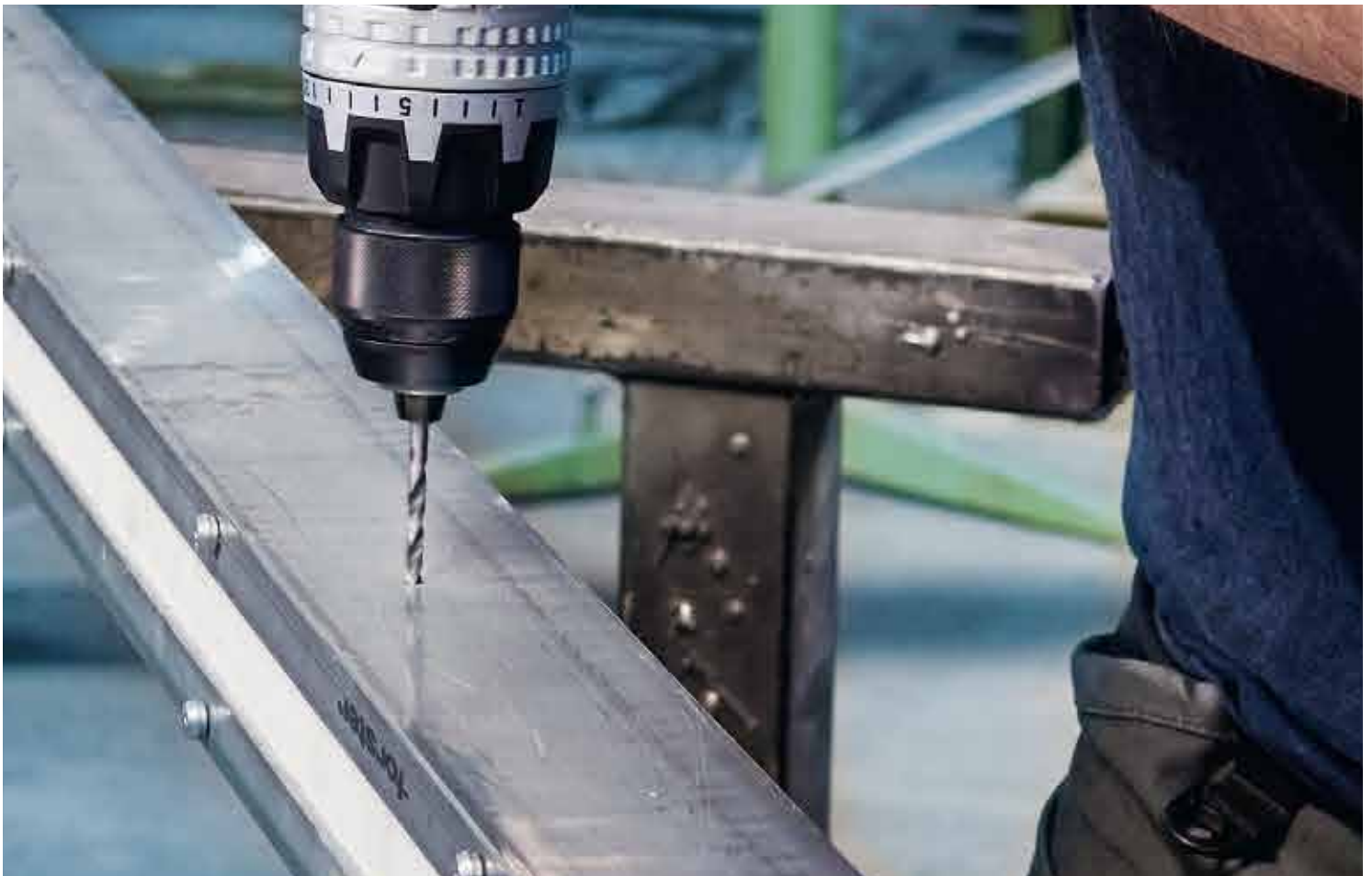

NEWLY LAUNCHED METAL DRILL BIT SETS

Bosch Professional Accessories.

HSS-Co Set



6 pcs
set

2608589296

2, 3, 4, 6, 8, 10* mm

HSS-G Sets (Robust Packaging)



6 pcs
set

2607010529

2, 3, 4, 5, 6, 8* mm



10 pcs
set

2607010535

1, 2, 3, 4, 5, 6, 7,
8, 9, 10* mm



13 pcs
set

2607010538

1.5, 2, 2.5, 3, 3.2, 3.5, 4,
4.5, 4.8, 5, 5.5, 6, 6.5* mm

PointTeq Sets



7 pcs
set

2608577347

2, 3, 4, 5, 6, 8* mm



10 pcs
set

2608577348

1, 2, 3, 4, 5, 6, 7,
8, 9, 10* mm



13 pcs
set

2608577349

1.5, 2, 2.5, 3, 3.2, 3.5, 4,
4.5, 4.8, 5, 5.5, 6, 6.5* mm

**METAL DRILL BITS HSS PointTeQ
DIN 338**



Part Number	Diameter mm	Working Length mm	Unit Pack Qty	List Price(₹)
2608577178	1	12	10	129
2608577179	1.1	14	10	108
2608577180	1.2	80	10	108
2608577181	1.3	16	10	108
2608577182	1.4	18	10	108
2608577183	1.5	18	10	129
2608577184	1.6	20	10	117
2608577185	1.7	20	10	117
2608577186	1.8	22	10	140
2608577187	1.9	22	10	117
2608577188	2	24	10	140
2608577189	2.1	24	10	125
2608577190	2.2	27	10	125
2608577191	2.3	27	10	125
2608577192	2.4	30	10	125
2608577193	2.5	30	10	150
2608577194	2.6	30	10	130
2608577195	2.7	33	10	130
2608577196	2.8	33	10	156
2608577197	2.9	33	10	130
2608577198	3	33	10	156
2608577199	3.1	36	10	156
2608577200	3.2	36	10	189
2608577201	3.3	36	10	189
2608577202	3.4	39	10	156
2608577203	3.5	39	10	189
2608577204	3.6	39	10	220
2608577205	3.7	39	10	220

**METAL DRILL BITS HSS PointTeQ
DIN 338**



Part Number	Diameter mm	Working Length mm	Unit Pack Qty	List Price(₹)
2608577206	3.8	43	10	220
2608577207	3.9	43	10	184
2608577208	4	43	10	260
2608577209	4.1	43	10	299
2608577210	4.2	43	10	299
2608577211	4.3	47	10	251
2608577212	4.4	47	10	251
2608577213	4.5	47	10	299
2608577214	4.6	47	10	301
2608577215	4.7	47	10	301
2608577216	4.8	52	10	359
2608577217	4.9	52	10	359
2608577218	5	52	10	359
2608577219	5.1	52	10	480
2608577220	5.2	52	10	401
2608577221	5.3	52	10	401
2608577222	5.4	57	10	401
2608577223	5.5	57	10	480
2608577224	5.6	57	10	434
2608577225	5.7	57	10	434
2608577226	5.8	57	10	434
2608577227	5.9	57	10	434
2608577228	6	57	10	519
2608577229	6.1	63	10	468
2608577230	6.2	63	10	559
2608577231	6.3	63	10	468
2608577232	6.4	63	10	468
2608577233	6.5	63	10	559

METAL DRILL BITS HSS PointTeQ DIN 338				
Part Number	Diameter mm	Working Length mm	Unit Pack Qty	List Price(₹)
2608577234	6.6	63	10	551
2608577235	6.7	63	10	551
2608577236	6.8	69	10	659
2608577237	6.9	69	10	551
2608577238	7	69	10	659
2608577239	7.1	69	10	618
2608577240	7.2	69	10	618
2608577241	7.3	69	10	739
2608577242	7.4	69	10	618
2608577243	7.5	69	10	739
2608577244	7.6	75	10	723
2608577245	7.7	75	10	723
2608577246	7.8	75	10	723
2608577247	7.9	75	10	723
2608577248	8	75	10	801
2608577249	8.1	75	10	835
2608577250	8.2	75	10	835
2608577251	8.3	75	10	835
2608577252	8.4	75	10	835
2608577253	8.5	75	10	886
2608577254	8.6	81	10	919
2608577255	8.7	81	10	919
2608577256	8.8	81	10	919
2608577257	8.9	81	10	919
2608577258	9	81	10	1,002
2608577259	9.1	81	10	1,021
2608577260	9.2	81	10	1,021

METAL DRILL BITS HSS PointTeQ DIN 338				
Part Number	Diameter mm	Working Length mm	Unit Pack Qty	List Price(₹)
2608577261	9.3	81	10	1,021
2608577262	9.4	81	10	1,021
2608577263	9.5	81	10	1,279
2608577264	9.6	87	10	1,119
2608577265	9.7	87	10	1,119
2608577266	9.8	87	10	1,119
2608577267	9.9	87	10	1,119
2608577268	10	87	10	1,170
2608577269	10.1	87	5	669
2608577270	10.2	87	5	669
2608577271	10.3	87	5	669
2608577272	10.4	87	5	669
2608577273	10.5	87	5	669
2608577275	10.7	94	5	752
2608577276	10.8	94	5	752
2608577277	10.9	94	5	752
2608577278	11	94	5	752
2608577280	11.2	94	5	801
2608577281	11.3	94	5	801
2608577282	11.4	94	5	801
2608577283	11.5	94	5	801
2608577285	11.7	94	5	868
2608577286	11.8	94	5	868
2608577287	11.9	101	5	868
2608577288	12	101	5	868
2608577289	12.1	101	5	893
2608577290	12.2	101	5	919
2608577291	12.3	101	5	919

METAL DRILL BITS HSS PointTeQ DIN 338				
Part Number	Diameter mm	Working Length mm	Unit Pack Qty	List Price(₹)

2608577292	12.4	101	5	919
2608577293	12.5	101	5	919
2608577294	12.6	101	5	1,002
2608577295	12.7	101	5	1,002
2608577296	12.8	101	5	1,002
2608577297	12.9	101	5	1,002
2608577298	13	101	5	1,198

METAL DRILL BITS HSS PointTeQ DIN 338				
Part Number	Diameter mm	Working Length mm	Unit Pack Qty	List Price(₹)

2608577316	1/16	23	10	141
2608577317	5/64	26	10	150
2608577318	3/32	33	10	166
2608577319	7/64	39	10	175
2608577320	1/8	42	10	200
2608577321	9/64	45	10	216
2608577322	5/32	52	10	265
2608577323	11/64	55	10	299
2608577324	3/16	61	10	366
2608577325	13/64	64	10	465
2608577326	7/32	66	10	499
2608577327	15/64	69	10	532
2608577328	1/4	72	10	582
2608577329	17/64	75	10	665
2608577330	9/32	77	10	748

METAL DRILL BITS HSS PointTeQ DIN 338				
Part Number	Diameter mm	Working Length mm	Unit Pack Qty	List Price(₹)

2608577331	19/64	80	10	748
2608577332	5/16	83	10	914
2608577333	21/64	87	10	997
2608577334	11/32	90	10	1,080
2608577335	23/64	92	10	1,247
2608577336	3/8	95	10	1,247
2608577337	25/64	98	10	1,330
2608577338	13/32	101	5	748
2608577339	27/64	101	5	831
2608577340	7/16	101	5	914
2608577341	29/64	101	5	914
2608577342	15/32	101	5	964
2608577343	31/64	101	5	1,080
2608577344	1/2	101	5	1,164

HSS-PointTeq metal drill bits

7-Price Metal Twist Drill HSS			
-------------------------------	--	--	---

Part Number	Diameter mm	Unit Pack Qty	List Price(₹)
2608577347	2, 3, 4, 5, 6, 8	7	466

10-Price Metal Twist Drill HSS			
--------------------------------	--	--	---

Part Number	Diameter mm	Unit Pack Qty	List Price(₹)
2608577348	1, 2, 3, 4, 5, 6, 7, 8, 9, 10	10	715

13-Price Metal Twist Drill HSS			
--------------------------------	--	--	---

Part Number	Diameter mm	Unit Pack Qty	List Price(₹)
2608577349	1.5, 2, 2.5, 3, 3.2, 3.5, 4, 4.5, 4.8, 5, 5.5, 6, 6.5	13	466

HSS Ground

Highest-Precision Holes



Excellent cutting features

135° tip design enables up to 40 % faster drilling rate and up to 50 % lower feed pressure than standard HSS drills with chisel edge.

Tight tolerances and accurate holes

As a result of its precision-ground drill bit body.

Quick start and perfect centering

Self-centering split point drills precisely where it is positioned. No need to pre-punch up to 10 mm diameter.

- ▶ HSS Ground is for drilling through metal with highest precision.
- ▶ Active cutting and perfect centering without wandering is achieved by split point tip.
- ▶ Precision-ground bit made of HSS enables fast results.
- ▶ No need to pre-punch or pilot drill up to 10 mm diameter.
- ▶ Manufactured to DIN 338, diameter tolerance h8.

METAL DRILL BITS HSS-G				
Part Number	Diameter Inch	Working Length x Total Length mm	Unit Pack Qty	List Price(₹)
2608585433	1/64	5x20	10	237
2608585434	1/32	10x30	10	237
2608585435	3/64	16x38	10	237
2608585436	1/16	20x43	10	237
2608585437	5/64	24x49	10	237
2608585438	3/32	30x57	10	237
2608585439	7/64	3x61	10	247
2608585440	1/8	36x65	10	260
2608585441	9/64	39x70	10	294
2608585442	5/32	43x75	10	330
2608585443	11/64	47x80	10	402
2608585444	3/16	52x86	10	526
2608585445	13/64	52x86	10	606
2608585446	7/32	57x93	10	635
2608585447	15/64	57x93	10	715
2608585448	1/4	63x101	10	765
2608585449	17/64	69x109	10	1,026
2608585450	9/32	69x109	10	1,056
2608585451	19/64	75x117	10	1,121
2608585452	5/16	75x117	10	1,170
2608585453	21/64	75x117	5	908
2608585454	11/32	81x125	5	857
2608585455	23/64	81x125	5	1,072
2608585456	3/8	87x133	5	1,142
2608585457	25/64	87x133	5	1,169
2608585458	12/32	87x133	5	1,204
2608585459	27/64	94x142	5	1,284
2608585460	7/16	94x142	5	1,461
2608585461	29/64	94x142	5	1,482
2608585462	15/32	101x151	5	1,632
2608585463	31/64	101x151	5	1,740
2608585464	1/2	101x151	5	2,215

METAL DRILL BITS HSS-G				
Part Number	Diameter mm	Working Length x Total Length mm	Unit Pack Qty	List Price(₹)
2608595049	1	12x34	10	173
2608585467	1.1	14x36	10	173
2608585468	1.2	16x38	10	173
2608585469	1.3	16x38	10	173
2608585470	1.4	18x40	10	173
2608595050	1.5	18x40	10	179
2608585471	1.6	20x43	10	190
2608585472	1.7	20x43	10	190
2608585473	1.8	22x46	10	188
2608585474	1.9	22x46	10	188
2608595051	2	24x49	10	193
2608585475	2.1	24x49	10	193
2608595052	2.2	27x53	10	193
2608585476	2.3	27x53	10	194
2608585477	2.4	30x57	10	197
2608595053	2.5	30x57	10	209
2608585478	2.6	30x57	10	209
2608585479	2.7	33x61	10	209
2608595054	2.8	33x61	10	213
2608585480	2.9	33x61	10	213
2608595055	3	33x61	10	230
2608585481	3.1	36x65	10	259
2608595056	3.2	36x65	10	264
2608595057	3.3	36x65	10	269
2608585482	3.4	39x70	10	271
2608595058	3.5	39x70	10	283
2608595332	3.6	39x70	10	283
2608585483	3.7	39x70	10	324
2608585484	3.8	43x75	10	340
2608585485	3.9	43x75	10	342
2608595059	4	43x75	10	356
2608585486	4.1	43x75	10	400
2608595060	4.2	43x75	10	412
2608585487	4.3	47x80	10	421
2608595333	4.4	47x80	10	435
2608595061	4.5	47x80	10	449

METAL DRILL BITS HSS-G				
				
Part Number	Diameter mm	Working Length x Total Length mm	Unit Pack Qty	List Price(₹)
2608585488	4.6	47x80	10	461
2608585489	4.7	47x80	10	467
2608595334	4.8	52x86	10	551
2608585490	4.9	52x86	10	566
2608595062	5	52x86	10	575
2608585491	5.1	52x86	10	607
2608595063	5.2	52x86	10	621
2608585492	5.3	52x86	10	621
2608585493	5.4	57x93	10	631
2608595064	5.5	57x93	10	638
2608585494	5.6	57x93	10	663
2608585495	5.7	57x93	10	678
2608595065	5.8	57x93	10	680
2608585496	5.9	57x93	10	688
2608595066	6	57x93	10	702
2608585497	6.1	63x101	10	704
2608595067	6.2	63x101	10	745
2608585498	6.3	63x101	10	768
2608595335	6.4	63x101	10	768
2608595068	6.5	63x101	10	871
2608585499	6.6	63x101	10	953
2608595336	6.7	63x101	10	959
2608595069	6.8	69x109	10	1,018
2608585500	6.9	69x109	10	1,035
2608595070	7	69x109	10	1,081
2608585501	7.1	69x109	10	1,084
2608595337	7.2	69x109	10	1,103
2608585502	7.3	69x109	10	1,103
2608585503	7.4	69x109	10	1,114
2608595071	7.5	69x109	10	1,114
2608585504	7.6	75x117	10	1,193
2608585505	7.7	75x117	10	1,250
2608585506	7.8	75x117	10	1,288
2608585507	7.9	75x117	10	1,321
2608595072	8	75x117	5	674

METAL DRILL BITS HSS-G				
				
Part Number	Diameter mm	Working Length x Total Length mm	Unit Pack Qty	List Price(₹)
2608585508	8.1	75x117	5	739
2608585509	8.2	75x117	5	755
2608585510	8.3	75x117	5	794
2608585511	8.4	75x117	5	794
2608595073	8.5	75x117	5	804
2608585512	8.6	81x125	5	821
2608585513	8.7	81x125	5	848
2608595074	8.8	81x125	5	856
2608585514	8.9	81x125	5	856
2608595075	9	81x125	5	856
2608585515	9.1	81x125	5	893
2608585516	9.2	81x125	5	938
2608585517	9.3	81x125	5	997
2608585518	9.4	81x125	5	997
2608595076	9.5	81x125	5	1,067
2608585519	9.6	87x133	5	1,103
2608585520	9.7	87x133	5	1,112
2608595338	9.8	87x133	5	1,127
2608585521	9.9	87x133	5	1,138
2608595077	10	87x133	5	1,139
2608585522	10.1	87x133	5	1,145
2608585523	10.2	87x133	5	1,145
2608585524	10.3	87x133	5	1,202
2608585525	10.4	87x133	5	1,224
2608595078	10.5	87x133	5	1,239
2608585526	10.6	87x133	5	1,249
2608585527	10.7	94x142	5	1,268
2608585528	10.8	94x142	5	1,268
2608585529	10.9	94x142	5	1,292
2608595079	11	94x142	5	1,307
2608585530	11.1	94x142	5	1,372
2608585531	11.2	94x142	5	1,375
2608585532	11.3	94x142	5	1,469
2608585533	11.4	94x142	5	1,469
2608595080	11.5	94x142	5	1,489
2608585534	11.6	94x142	5	1,584
2608585535	11.7	94x142	5	1,590

METAL DRILL BITS HSS-G



Part Number	Diameter mm	Working Length x Total Length mm	Unit Pack Qty	List Price(₹)
2608585536	11.8	94x142	5	1,597
2608585537	11.9	101x151	5	1,648
2608595081	12	101x151	5	1,648
2608585538	12.1	101x151	5	1,689
2608585539	12.2	101x151	5	1,697
2608585540	12.3	101x151	5	1,719
2608585541	12.4	101x151	5	1,719
2608595082	12.5	101x151	5	1,719
2608585542	12.6	101x151	5	1,882
2608585543	12.7	101x151	5	1,997
2608585544	12.8	101x151	5	2,165
2608585545	12.9	101x151	5	2,233
2608595083	13	101x151	5	2,273
2608585593 (Reduced shank)	14	108x160	4	3,486
2608585595 (Reduced shank)	16	114x169	4	4,254

METAL DRILL BITS* - COBALT RANGE



Part Number	Diameter mm	Working Length x Total Length mm	Unit Pack Qty	List Price(₹)
2608585872	1	12 x 34	10	240
2608585875	2.5	30 x 57	10	324
2608585878	3.3	36 x 65	10	584
2608585879	3.5	39 x 70	10	588
2608588092	3.8	43 x 75	10	736
2608585880	4	43 x 75	10	745
2608585883	4.5	47 x 80	10	954
2608585885	5	57 x 93	10	1,185
2608585889	6	57 x 93	10	1,735
2608585892	7	69 x 109	10	2,646
2608585894	8	57 x 93	5	1,758
2608585895	8.5	75 x 117	5	2,012
2608585898	10	57 x 93	5	3,053
2608585901	11	94 x 142	5	3,616
2608585903	12	57 x 93	5	4,514
2608585904	12.5	101 x 151	5	5,179
2608585905	13	101 x 151	5	5,338

*For full range price upon request





HSS-R sets

Part Number	Image	Diameter mm	Unit Pack Qty	List Price(₹)
-------------	-------	-------------	---------------	---------------

2609255030		1.2/2.0/3.0/ 4.0/5.0/6.0/ 7.0/8.0/9.0/10.0	10	519
------------	---	--	----	-----

2607019442		1/2/3/4/5/ 6/7/8/9/10	10	722
------------	---	--------------------------	----	-----

2607019441		1.5/2/2.5/3/3.2/ 3.5/4 /4.5/4.8/ 5/5.5/6/6.5	13	613
------------	---	--	----	-----

2607019446		1/1.5/2/2.5/3/ 3.5/4/4.5/5/5.5/6 6.5/7/7.5/8/8.5/9 9.5/10/10.5/11/ 11.5/12/12.5/13	25	2,260
------------	--	--	----	-------

2607018354		1.5/6.5/0.5/ 3.2/4.8	19	1,673
------------	---	-------------------------	----	-------

New! HSS-PointTeq Sets

Part Number	Image	Diameter mm	Unit Pack Qty	List Price(₹)
-------------	-------	-------------	---------------	---------------

2608577347		2/3/4/5/6/8	7	466
------------	---	-------------	---	-----

2608577348		1/2/3/4/5/6/7/ 8/9/10	10	715
------------	---	--------------------------	----	-----

2608577349		1.5/2/2.5/3/3.2/ 3.5/4/4.5/4.8/5/ 5.5/6/6.5	13	466
------------	---	---	----	-----

HSS-G

New! Robust Packaging sets

Part Number	Image	Diameter mm	Unit Pack Qty	List Price(₹)
-------------	-------	-------------	---------------	---------------

2607010529		2.0/3.0/4.0/ 5.0/6.0/8.0	6	887
------------	--	-----------------------------	---	-----

2607010535		1.0/2.0/3.0/4.0/ 5.0/6.0/7.0/8.0/ 9.0/10.0	10	1,555
------------	--	--	----	-------

2607010538		1.5-6.5/x0.5/ 3.2/4.8	13	1,245
------------	--	--------------------------	----	-------

Cassette Packing

Part Number	Image	Diameter mm	Unit Pack Qty	List Price(₹)
-------------	-------	-------------	---------------	---------------

2607019115* New! 2607010535		1.0/2.0/3.0/4.0/ 5.0/6.0/7.0/8.0/ 9.0/10.0	10	1,555
-----------------------------------	---	--	----	-------

2607018727* New! 2608587017		1/1.5/2/2.5/3/3.5/ 4/4.5/5/5.5/6/6.5/ 7/7.5/8/8.5/9/9.5/ 10/10.5/11/11.5/ 12/12.5/13	25	3,122
-----------------------------------	--	--	----	-------

HSS-G (TIN)

Part Number	Image	Diameter mm	Unit Pack Qty	List Price(₹)
-------------	-------	-------------	---------------	---------------

2607019436		1.5/2.0/2.5/3.0, 3.2/3.5/4.0/4.5, 4.8/5.0/5.5/6.0/6.5"	13	538
------------	--	--	----	-----

2607017152		Ø1.5/2/2.5/3/ 3.5/4/4.5/5/5.5/6/ 6.5/7/7.5/8/8.5/ 9/9.5/10	19	967
------------	--	---	----	-----

HSS-Co

7-Price HSS CO SET

NEW!



Part Number	Diameter mm	Unit Pack Qty	List Price(₹)
-------------	-------------	---------------	---------------

2608589296	2/3/4/5/6/8/10	7	1,245
------------	----------------	---	-------

*New part number prices will be revised post clearance of old stock.

NEW!

NEW!

NEW!

unit Pack Qty	HSS-R Sets	HSS- PointTeq Sets	HSS-TIN	HSS-G Sets	HSS-G with Robust packaging	HSS-Co
6 pcs set					 2607010529	
7 pcs set		 2608577347				 2608589296
10 pcs set	 2607019442 2609255030	 2608577348		 2607019115	 2607010535	
13 pcs set	 2607019441	 2608577349	 2607019436		 2607010538	
19 pcs set	 2607018354		 2607017152			
25 pcs set	 2607019446			 2607018727		



CARBIDE ANNULAR CUTTER FOR EFFORTLESS DRILLING

Universal use

19mm universal shank fits to magnetic drill with Universal or Weldon interface.



Fast and effortless drilling

The "Inner-middle-outer" tip combination minimizes friction and heat for higher cutting performance.

High sharpness tip

Optimized tip geometry leads to extra cutting rate for annular drilling.



► TUNGSTEN CARBIDE TEETH ANNULAR CUTTER

Part Number	Dia mm	Cutting Depth mm	PIN to Fit	PIN Part Number	Unit Pack Qty	List Price(₹)
2608577483	14	35	PL6035	2608577507	1	1,516
2608577484	16	35	PL6035	2608577507	1	1,516
2608577485	18	35	PL8035	2608577508	1	1,516
2608577486	20	35	PL8035	2608577508	1	1,516
2608577487	22	35	PL8035	2608577508	1	1,589
2608577488	24	35	PL8035	2608577508	1	1,589
2608577489	26	35	PL8035	2608577508	1	1,661
2608577490	28	35	PL8035	2608577508	1	1,661
2608577491	30	35	PL8035	2608577508	1	1,618
2608577492	32	35	PL8035	2608577508	1	1,950
2608577493	35	35	PL8035	2608577508	1	1,950
2608577494	40	35	PL8035	2608577508	1	2,311
2608577495	14	50	PL6050	2608577509	1	1,734
2608577496	16	50	PL6050	2608577509	1	1,734
2608577497	18	50	PL8050	2608577510	1	1,734
2608577498	20	50	PL8050	2608577510	1	1,734
2608577499	22	50	PL8050	2608577510	1	1,806
2608577500	24	50	PL8050	2608577510	1	1,806
2608577501	26	50	PL8050	2608577510	1	1,950
2608577502	28	50	PL8050	2608577510	1	1,950
2608577503	30	50	PL8050	2608577510	1	1,907
2608577504	32	50	PL8050	2608577510	1	2,240
2608577505	35	50	PL8050	2608577510	1	2,240
2608577506	40	50	PL8050	2608577510	1	2,601

► PIN

Part Number	Product Description	Diameter mm	Length mm	Unit Pack Qty	List Price(₹)
2608577507	PL6035	6.3	90	5	216
2608577508	PL8035	8.0	90	5	216
2608577509	PL6050	6.34	106	5	231
2608577510	PL8050	8.0	106	5	231

* PIN sold separately in pack of 5.

► ADAPTORS FOR MAGNETIC DRILL MACHINE

Part Number	1608571056
Price ₹	2,698
Description	Keyed Drill Chucks up to 16 mm
Chuck capacity mm	3.0 – 16.0
Mount, range	5/8" – 16
Impact-proof	●
Replacement key	A
R/L rotation	●
Locking mechanism	–
Bench-mounted drill	●
Illustration	No.1
Carton Box Qty	12

► ADAPTORS FOR MAGNETIC DRILL MACHINE

Part Number	Description	List Price(₹)
1603115004	Morse taper MT 2 to 5/8" for use of chucks with capacity of up to 16 mm, 5/8"-16 UNF Suitable for GBM 23-2; GBM 23-2 E; GBM 32-4; GBM 50-2 Professional	1,356
1608598028	Reduction sleeve MT 2 to MT 1 Suitable for GBM 23-2; GBM 23-2 E; GBM 32-4; GBM 50-2 Professional	640

MIXED SETS



PICK AND CLICK

Pick your accessory and click it in
All bits are with Hex Shank

Now!
With
Holder!



HSS PointTeQ with Hex Shank

High speed drill

While keeping expected drill bit durability

1/4" HEX shank

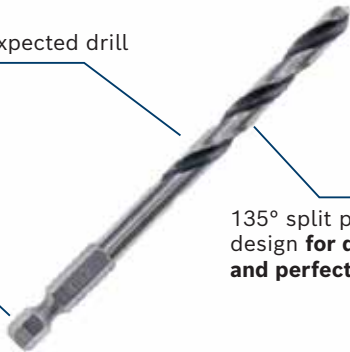

135° split point tip design for quick start and perfect entering

Colour ring SDB now with magnetic

S2 material and with magnetic

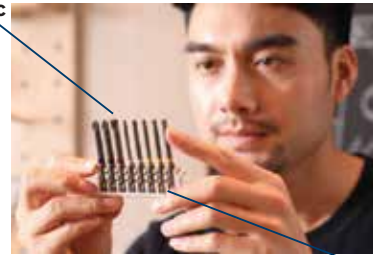

Tip size easily recognized

Easy pick and click indexes

Easy click: Allows clips to be easily installed or removed from case



Easier Tilt-in/Tilt-out Mechanism



Robust case

Clear cover

Provides ability to see bits inside case



Robust case

Rubber bumpers for tough environment

Secure close

Strong latch keeps bits safely stored in case

44/45 PCS WITH A SCREWDRIVER HOLDER BITS SET



Part Number	Description	Unit Pack Qty	List Price(₹)
*2608522421	44 pcs mixed screwdriver bits set	44	1,791
2607017692	45 pcs mixed screwdriver bits set with holder	45	1,703

X-line Titanium set family

Components	X30Ti	X34Ti	X40Ti	X50Ti	X70Ti+ 3 Pliers	X103Ti
Part Number	2607019324	2607010608	2607019600	2607019327	2607017197	2607019331
List Price(₹)	875	686	2,347	1,666	3,954	4,344
Metal Drill Bits	11	5	11	11	11	18
Masonry Drill Bits	4	5	4	6	7	7
Wood Drill Bits	4	5	4	5	5	7
Rasp Bits	-	-	-	-	3	-
Spade Bits	-	-	3	2	-	3
Depth Stops	-	-	-	-	-	3
Screwdriver Bits-25 mm	10	13	16	18	23	40
Screwdriver Bits-50 mm	-	-	-	-	10	-
Hex Socket Wrenches	-	-	-	-	-	-
Adapter for Socket	-	-	-	-	-	-
Nutsetters	-	3	-	3	7(Hex)	8
Adapter for Nutsetter	-	1	-	1	-	-
Magnetic Universal Holder	11	1	1	1	2	-
Countersink Bit	1	1	1	1	1	1
Holesaws	-	-	-	-	-	3

a.Diameter
b.Knife
a.Hand screwdriver
b.Extension shank
a.Tape measure
b.3 Pliers
c.2 Tool holders

a.Diameter
b.Knife
c.Hand screwdriver
d.Extension shank

a.1 Diameter gauge
b.1 Tape measure
c.1 Spirit level
d.1 Allen key for nutsetters
e.1 Adapter for nutsetters
f. Adapter for hole-saws
g. Hammer
h. 3 Pliers

Screwdriving section family

Components	7-Price Pocket Screwdriver	10-Price Screwdriver Bit Set	10-Price Ratchet Pocket	25-Price Big Bit Screwdriver	26-Price Screwdriver Bit	27-Price Drill & Screwdriver	32-Price Screwdriver Bit Set	38-Price Mixed Set	44-Price Screwdriver Set	45-Price Screwdriver Set	46-Price Screwdriver Set
Part Number	2607017180	2607019454	2607019510	2607019503	2607017322	2607017201	2607017063	2607019506	2608522421	2607017692	2607019504
List Price(₹)	1,140	708	427	570	2,036	1,120	1,017	1,290	1,739	1,654	939
Screwdriver Bits	6	9	9	25	26	27	32	23	25	25	46
Length	25	25	25	25	25	25	25	25	25/65	25/65	30
PH	2	1/2/3	1/2	1/1/2/2/3	1/2/2/3	-	1/2/2/3	1/2/2/3	25mm: 1/2/2/3 65mm: 2	25mm: 1/2/2/3 65mm: 2	0/1/2/3
PZ	2	1/2/3	1/2/3	1/1/2/2/3	1/2/3	-	1/2/2/3	0/1/1/2/2/3	25mm: 1/2/2/3 65mm: 2	25mm: 1/2/2/3 65mm: 2	0/1/2/3
SL	6	4.5/5.5/8	-	4/4/6/6/7/7	4/5/6	-	3/4/5/6	4/6/7	25mm: 3/4/5/6 65mm: 6	25mm: 3/4/5/6 65mm: 6	3/4/4.5/5/6/7/8/9
HEX	4/5	-	4/5	-	-	3/4/5/6	3/4/5/6	3/4/5/6	25mm: 3/4/5/6 65mm: 3/4	25mm: 3/4/5/6 65mm: 3/4	1.5/2/2.5/3
T	25	-	20/25	1.5/2/2.5/3/ 25/30/30	10/15/20/ 25/30	-	10/15/20/ 20 25/27/ 30/40	15/20/ 25/40	10/15/20/ 25/ 27/30/40	10/15/20/ 25/ 27/30/40	8/10/15/20/ 25/27/30/40
Nutsetters	-	-	-	-	-	4 nutsetters	7 nutsetters	-	6/8/10	6/8/10	12 nutsetters
Others	1 Hand Screwdriver	1 Universal Holder	1 Hand Screwdriver	1 Universal Holder	1 Universal Holder	1	1 Universal Holder	1 Universal Holder	1 Universal Holder	1 Universal Holder + 1 Screwdriver	1 Universal Holder
Unit Pack Qty	7	10	10	25	26	27	32	38	44	45	46
User Benefits: 1.	7 integrated screwdriver bits with most commonly used screw head types & sizes	High-grade screwdriver bits that prevent rust and damages	Includes durable screwdriver bits to fit the most common screw types and sizes	Magnetic universal holder for fast bit changes	Easy bit selection due to colour code and clear layout	Clear layout and easy removal of attachments	Easy bit selection due to colour code and clear layout	2 magnetic universal holders for fast bit changes and a reliable screw hold in the bit	All screwdriver bits come with magnetism and are color coded for easy identification	All screwdriver bits come with magnetism and are color coded for easy identification	Manual screwdriver with ratchet function and bit storage in the handle
2.	Slacken or tighten screws in hard to reach areas even in bicycles or snowboards	Magnetic universal holder for fast bit changes	Bits housed in the body of the screwdriver for easy access	Comes in a convenient plastic drum which can be used as a manual screwdriver	Ratchet for fastening or loosening screws	High grade rubberised plastic handle for comfort	Magnetic, quality quick-change adaptor with auto-lock	Handy soft bag for neat storage of all accessories	The clips holding the bits can be easily clicked in and taken out	The bits from the clips can be tilted out for easy removal	Magnetic universal holder for fast bit changes and a reliable screw hold in the bit

MULTITOOL			
Part Number	Description	Unit Pack Qty	List Price(₹)
2609256D91	12-in-1 Multitool 1-pc Knife, 1-Price Saw, 1-pc Can Opener, 1-pc Small Slotted Screwdriver, 1-pc Medium Slotted Screwdriver, 1-pc Wire Stripper, 1-pc Pliers, 1-pc Wire Cutter, 1-pc Large Slotted Screw- driver/Bottle Opener, 1-pc Cross-Head, 1-pc File and 1-pc Blade (Serrated)	1	761

SCREWDRIVER BIT SETS			
Part Number	Description	Unit Pack Qty	List Price(₹)
2607019503	25-pcs "Big Bit" screwdriver bit set Lipstick Set 24 screw- driver bits, L=25 mm, PH 1/1/2/2/3/3,0 PZ 1/1/2/2/3/3, S 4/4/6/6/7/7, T 20/20/25/25/30/301 universal holder, magnetic	25	554

SCREWDRIVER BIT SETS			
Part Number	Description	Unit Pack Qty	List Price(₹)

2607017180	7-pcs "Pocket" screwdriver bit set 6 screwdriver bits, L = 25 mm PH 2, PZ 2,S 6, HEX 4/5, T 25 1 hand screwdriver, ratchet function clockwise/ counter clockwise	7	1,107
------------	---	---	-------

2607019454	10-pcs screwdriver bit set 9 screwdriver bits L = 25 mm, PH 1/2/3, PZ 1/2/3, S 4.5/5.5/81 universal holder, magnetic	10	687
------------	--	----	-----

2607019510	10-pcs "Pocket" screwdriver bit set 9 screwdriver bits L = 25 mm PH 1/2, PZ 1/2/3, HEX 4/5, T 20/25 1 hand screwdriver, ratchet function clockwise/counter- clockwise	10	415
------------	--	----	-----

2607017322	26-pcs screwdriver bit and ratchet set 19 screwdriver bits with colour coding L = 25 mm, PH 1/2/2/3, PZ 1/2/3, S 4/5/6, T 10/15/20/25/30, HEX 3/4/5/6 4 nutsetters, width across flats: 6/8/10/ 13 mm 1 ratchet (clockwise/ counter clockwise) 1 universal holder, magnetic 1 adapter for nutsetters	26	1,977
------------	--	----	-------

2607017063	32-Price screwdriver bit set with colour coding 31 screwdriver bits with colour coding, L = 25 mm PH 1/2/2/3, PZ 1/2/2/3, S 3/4/5/6, HEX 3/4/5/6, T 10/15/20/20/25/27/ 30/40, Th 10/15/20/25/ 27/ 30/40, 1 quick-change universal holder magnetic	27	1,047
------------	---	----	-------

SCREWDRIVER BIT SETS



Part Number	Description	Unit Pack Qty	List Price(₹)
2607017201	27-pcs drill and screwdriver bit set 5 metal drill (Ø 2/2/3/4/5 mm), 5 wood drill (Ø 4/5/6/7/8 mm), 5 masonry drill (Ø 5/5.5/6/7/8 mm), 10 screwdriver bits, (PH 1/2/2/3), (PZ 1/2/2/3) (S 4/6), 1 magnetic universal holder (L = 60 mm), 1 hand screwdriver as an extra	27	1,154



SCREWDRIVER BIT SETS



Part Number	Description	Unit Pack Qty	List Price(₹)
2607019504	46 pcs Screwdriver Set 32 screwdriver bits L = 30 mm; PH 0/1/2/3; PZ 0/1/2/3; S 3/4/4.5/5/6/7/8/9; HEX 1.5/2/2.5/3/4/5/5.5/6; T 8/10/15/20/25/27/30/40 12 nutsetters for hex screws 3/16", 1/4", 5/16", 11/32", 3/8", 7/16", 6/7/8/10/11/13 mm 1 universal holder, magnetic; 1 hand screwdriver, ratchet function clockwise/ counter- clockwise Bit garage in the handle	46	912



2607019506	38 pcs Mixed Set 23 screwdriver bits, L=25 mm, PH 0/1/1/2/2/3, PZ 0/1/1/2/2/3, S 4/6/7, HEX 3/4/5/6, T 15/20/25/40 7 nutsetters, Ø 5/6/7/8/10/11/13 mm 4 hex keys 3/4/5/6 mm 1 universal holder, magnetic 1 torch, 1 hand screwdriver, ratchet function clockwise/ counter-clockwise 1 adapter for nutsetters	38	1,252
------------	--	----	-------



New! 2608522421	44 pcs Mixed Screwdriver bits set 25mm: SDB PH1/2/2/3; PZ1/2/2/3; SL3/4/5/6; HEX: 3/4/5/6; T10/15/20/25/27/30/40; TH10/15/20/25/27/30/40 65mm: power bits PH2; PZ2; SL6; T15/20/25; H3/4 Nutsetter: 6/8/10; quick change bits holder 1 pc	44	1,739
---------------------------	--	----	-------



2607017316	41 pcs V-Line Drill Bit and Screwdriver Bit Set with Angle Driver 1 angle driver; 7 HSS-R metal drill bits, Ø 2-6 mm 6 masonry drill bits, Ø 5-8 mm; 5 wood drill bits, Ø 3-8 mm, 2 spade bits, Ø 16/20 mm; 11 screwdriver bits, L = 25 mm; PH 1/2; PZ 1/2; S 4/5/6, T 20, H 4/5/6 6 nutsetters, Ø 6/8/9/10/11/13 mm, 1 universal holder, magnetic, 1 countersink	41	2,657
------------	--	----	-------



New! 2607017692	45 pcs Mixed Screwdriver bits set + additional screw handle 25mm: SDB PH1/2/2/3; PZ1/2/2/3; SL3/4/5/6; HEX: 3/4/5/6; T10/15/20/25/27/30/40; TH10/15/20/25/27/30/40 65mm: power bits PH2; PZ2; SL6; T15/20/25; H3/4 Nutsetter: 6/8/10; quick change bits holder 1 pc	1	1,654
---------------------------	--	---	-------



X LINE TITANIUM SETS



Part Number	Description	Unit Pack Qty	List Price(₹)
2607017197	70 pcs X-Line accessory case + 3 with 12-in-1 multitool free with the set 7 masonry drill bits • 4.0/5.0/5.5/6.0/7.0/8.0/10 mm 5 wood drill bits PTCN drill 4x75/5x85/6x100/8 mm/ 10 mm 3 rasp drill bits Screwdriver bits L 25 mm PH 0/1/1/2/2/3, PZ 0/1/ 1/2/2/3, LS 4/6/7. HEX 3/4/5/6, T 15/20/25/40 Screwdriver bits L 50 mm • PH 1/2/3 PZ 1/2/3 • LS 4/6 T 20/25 • 7 hex nutsetters • 4/5/6/7/8/9/10 mm 2 tool holders, 1 countersink, 1 tape measure, 1 combination pliers, 1 flat pliers, 1 open-ended spanner	70	4,072



2607019331	103 pcs X-Line Titanium set 18 HSS-TiN metal drill bits, Ø 1-10 mm, 7 masonry drill bits, Ø 3-8 mm 7 wood drill bits, Ø 3-10 mm 3 spade bits, Titanium, Ø 16/22/32 mm 4 depth stops, Ø 3/5/8/10 mm 40 screwdriver bits, L = 25 mm PH 0/0/1/1/2/2/2/3/3/3, PZ 0/0/1/1/2/2/2/3/3/3, S 4/4/6/6/7/7, HEX 3/4/5/6, T10/10/15/15/20/20/25/25/30/40 8 nutsetters, Ø 5/6/7/8/9/10/ 11/13 mm 4 HCS holesaws, Ø 32/38/45/54 mm 1 diameter gauge, 1 countersink, 1 tape measure, 1 spirit level, 1 allen key, 1 universal holder, magnetic, 1 adapter for nutsetters, 1 adapter for holesaws, 1 hammer, 1 adjustable spanner, 1 pair of long nose pliers, 1 pair of combination pliers	103	4,218
------------	--	-----	-------



2607017200	Accessory set Mini-X-Line sets	33	2,579
------------	--------------------------------	----	-------



MIXED SETS



Part Number	Description	Unit Pack Qty	List Price(₹)
New! 2608522422	20 pcs Mixed Drill and Drive set 4 x 25 mm Insert Bits (PH 1/2/2/3); 1 x 25 mm Insert Bits (PZ 2); 2 x 25 mm Insert Bits (SL 4/6) 2 x 25 mm Insert Bits (HEX 5/6) 3 x 25mm Insert Bits (T 15/20/25) 4 x 65 mm Power Bits (PH2, S6, H3, H4) 1 x Bits Holder (55.5 mm) 3 x HSS PointTeQ (4/5/6 mm)	20	1,612





New! 2607011660	73 pcs Mixed set 1x cutter knife 1x combination pliers 1x hammer 1x measuring tape 1x hand screwdriver 1x magnetic bit holder 1x counter sink 7x wood drills (3/4/5/6/7/8/10 mm) 3x metal drills (3/4/6 mm) 5x masonry drills (4/5/6/8/10 mm) 18x screws (3 sizes) 18x plastic plugs (3 sizes) 15x SDBs (PH 1/2/2/3; PZ 1/2/2/3; S 4/6/7; T 15/20/25/30)	73	2,627
---------------------------	---	----	-------



HANDTOOL SETS



Part Number	Description	Unit Pack Qty	List Price(₹)
2607002790	 108 pcs set Mixed set 10 screwdriver bits, L= 25mm, PH 1/2/2/3, SL 6/7, Hex 5/6, Torx 15/20 6 Hex socket wrench 5/6/7/ 8/9/10 1 Adaptor hex - 1/4" square 8 precision bit, L= 28 mm PH000/PH00 T6 five star 0.8 mm/0.8 mm/1.2 mm SL 1.5 mm/2 mm 1 Adaptor 6.35 mm 4 mm, 1 screwdriver with ratchet 3 masonry drill bits 5/6/8, 8 Allen Key 1.5 mm/2mm/2.5 mm/3 mm/ 4 mm/5 mm/5.5 mm/ 6 mm 1 Pliers 1 Long Nose Plier 1 Hammer 1 Open-end spanner 1 Cutter 1 HandSaw 1 Measuring tape 3m 1 Test Pen 1 Tape 1 Torch 10 Wood screw (3.0x30) 10 Wood screw (4.0x35) 10 Wood screw (5.5x50) 10 Dowel Plug (5x30) 10 Dowel Plug (6x30) 10 Dowel Plug (8x35)	108	2,598

2607002791	 12 pcs set Mixed set 6 Screwdriver Bit 25 mm PH1/PH2/S6/S7/H6/T15 1 Hand Screwdriver Flat-Nose Pliers Nose plier 1 Hammer 1 Open-End Spanner Adjustable 1 Tape Measure 1 Adaptor hex - 1/4" square	12	1,333
------------	--	----	-------

2607002792	 66 pcs set Mixed set 7 Screwdriver Bit 5 mm PH1/PH2*2/S6/S7/H6/T15 8 Precision Bit 4*28mm PH00/PH000*2/SL1.5/SL2 /Star 0.8*2/Start 1.2 1 Cutter 1 Electroprobe 1 Insulation tape 20 Wood Screw (4.0x35)/ (5.0x50) H type 20 Dowel Plug (6x30)/(8x35) 1 Hand Screwdriver 1 Flat-Nose Pliers Nose plier 1 Hammer 1 Open-End Spanner Adjustable 1 Tape Measure 1 Mansory 6 mmx100 mm 1 Adaptor 6.35 mm-4 mm 1 Torch	66	1,973
------------	---	----	-------

HANDTOOL SETS IN CANVAS BAG



Part Number	Description	Unit Pack Qty	List Price(₹)
-------------	-------------	---------------	---------------

2607017540	11 pcs screwdriver bits set for IN	11	447
------------	------------------------------------	----	-----



2607017542	12 pcs Multi-function mixed set, with ratcheting screwdriver for IN	12	759
------------	---	----	-----



2607017543	14 pcs Multi-function mixed set, with ratcheting screwdriver for IN	14	1,027
------------	---	----	-------



2607017544	15 pcs Multi-function mixed set for IN	15	1,034
------------	--	----	-------



SYSTEM ACCESSORIES



STARLOCK

STARLOCK SANDING PLATE

- AVZ 93 G
- Sanding plate with miro hook- and-loop-type fastening system
- Quick, easy sanding sheet change



New Pro Part Number	Description	Diameter mm	Pack Qty	List Price ₹
2608669125	AVZ93 G	93	1	580

STARLOCK BIM SEGMENT SAW BLADE ACZ 85 EB WOOD AND METAL

- ACZ 85 EB
- Starlock BIM segment saw blade Wood and Metal, with depressed centre
- Cutting a door frame to length on the floor (softwood, hardwood, veneered panels, plastic-laminated panels)
- Cutting out laminate/parquet (e.g. for installing a partition wall)
- Cutting smaller mouldings to length (e.g. aluminium floor cover strips)



New Pro Part Number	Description	Diameter mm	Pack Qty	List Price ₹
2608669086	ACZ85EIB	85	1	1,350

STARLOCK CARBIDE-RIFF SEGMENT SAW BLADE ACZ 85 RT3 GROUT AND ABRASIVE

- ACZ 85 RT3
- Starlock Carbide-RIFF segment saw blade
- Routing joints on wall and floor tiles
- Routing smaller cutouts in soft wall tiles
- Routing grooves in porous concrete, for laying concealed cables and pipes



New Pro Part Number	Description	Diameter mm	Pack Qty	List Price ₹
2608669120	ACZ85 RT3	85	1	1,950

STARLOCK BIM PLUNGE CUT SAW BLADE AIZ 32 APB WOOD AND METAL

- AIZ 32 APB
- Starlock BIM plunge cut saw blade Wood and Metal
- Plunge cut in wood, abrasive wooden materials, plastics
- Cutting non-ferrous pipes and profiles with smaller dimensions
- Cutting non-hardened nails, screws and steel profiles with smaller dimensions



New Pro Part Number	Description	Working width mm	Working Depth mm	Pack Qty	List Price ₹
2608669066	AIZ 32 APIB	32	50	1	1,023

STARLOCK BIM PLUNGE CUT SAW BLADE AIZ 32 BSPB HARD WOOD

- AIZ 32 BSPB
- Starlock BIM plunge cut saw blade Hard Wood
- Plunge cutting in laminated panels or hardwood (e.g. for installing a ventilation grille)
- Cutting a recess in furniture components (e.g. to enable access to a mains socket)
- Flush cutting wooden components (e.g. dowels, tenons made of hardwood) to length



New Pro Part Number	Description	Working width mm	Working Depth mm	Pack Qty	List Price ₹
2608669070	AIZ 32 BSPB	32	50	1	750

HANDHELD TACKER HT 8

Quick fastening made easy



NEW!

BENEFITS/WHY BOSCH?

- ▶ Suitable for quick fixing of fabrics, foils, insulation material, etc.
- ▶ Robust, polished steel, with padded grip and grip-lock
- ▶ Appropriate staple type 53, length of 4, 6, 8 mm

MATERIALS: Textiles, cardboard, flat wooden slats, woven wire



HANDHELD TACKER HT 14

Quick fastening made easy



NEW!

BENEFITS/WHY BOSCH?

- ▶ Suitable for quick fixing of fabrics, roofing felt, foils, insulation materials, woven wires and for light upholstery work, etc.
- ▶ Multi-purpose tacker made of robust, polished steel, with continuously variable power adjustment, padded grip and grip-lock
- ▶ Appropriate staple type 53, length of 4, 6, 8, 10, 12, 14 mm, appropriate pin type 41, length of 14 mm

MATERIALS: Fabrics, roof felt, foils, insulation materials, woven wires, and for light upholstery work



HANDHELD TACKER HT 8 **NEW!**



Part Number	Description	Unit Pack Qty	List Price(₹)
0603038000	Handheld Tacker HT8	1	641

HANDHELD TACKER HT 14 **NEW!**



Part Number	Description	Unit Pack Qty	List Price(₹)
0603038001	Handheld Tacker HT14	1	799

STAPLES Pins, type 41 **NEW!**



Part Number	Length mm	Unit Pack Qty	List Price(₹)
2609200292	14	1000	349

STAPLES Fine wire staples, Type 53 **NEW!**



Part Number	Length mm	Unit Pack Qty	List Price(₹)
2609200291	4	1000	172
1609200326	6	1000	172
1609200365	8	1000	180
1609200366	10	1000	187
1609200367	12	1000	203
1609200368	14	1000	219

SCREWDRIVER BIT SET			
Part Number	Description	Unit Pack Qty	List Price(₹)

2607002821



Fuchsia screwdriver bits set

1

562

2607002822



Blue screwdriver bits set

1

512

2607002823



vert screwdriver bits set

1

512

SETS			
Part Number	Description	Unit Pack Qty	List Price(₹)

2607017395



Bosch Professional 103-piece Bosch Blue X-Line titanium set for wood, masonry and metal.

1

3,940

2607017396



Bosch Professional 41-piece Bosch Blue V-Line set for drilling and screwdriving, comes with offset screwdriver.

1

1,500

2607017400



Bosch 25-piece Bosch Mini-X-Line screwdriver bit set

1

396

2607017401



Bosch Professional 30-piece Bosch Blue X-Line titanium set.

1

970

2607017405



Bosch Comprehensive X-Line Drill Driver Bit & Screwdriver Bit Set, Set Of 34 Pcs

1

874

2607017406



Bosch Premium X-Line Mixed Drill Bits / Screw Bits And Accessory Kit Set, Set Of 50 Pcs

1

1,644

2607017408



Bosch Professional 15 pc Mini X Line with Masonry bits, wood drill bits and screwdriver bits

1

352

SETS			
Part Number	Description	Unit Pack Qty	List Price(₹)

2607017413



Bosch Professional 103-piece Bosch Blue X-Line titanium set for wood, masonry and metal.

1

3,940

2607017504



Bosch Professional 41-piece Bosch Blue V-Line set for drilling and screwdriving, comes with offset screwdriver.

1

1,500

2607017505



Bosch 25-piece Bosch Mini-X-Line screwdriver bit set

1

396

2607017506



Bosch Professional 30-piece Bosch Blue X-Line titanium set.

1

970

2607017508



Bosch Comprehensive X-Line Drill Driver Bit & Screwdriver Bit Set, Set Of 34 Pcs

1

874

2607017413



Bosch 10 Pcs Pocket Screwdriver Bit Set

1

427

2607017504



Bosch Professional 15 pcs wood + metal + masonry drill bit set

1

529

2607017505



Bosch Professional 7pcs X-Line Mini Wood Drill Bit Set

1

286

2607017506



Bosch Comprehensive The Bosch 173-piece Fixing Set is a complete set for any drilling and fixing job

1

1,044











2607017508



Bosch Professional 7pcs X-Line Mini metal Drill Bit Set

1

438

SETS			
Part Number	Description	Unit Pack Qty	List Price(₹)
2607017509	Bosch Professional 7pcs X-Line Mini Masonry Drill Bit Set	1	269
			
2607017511	Bosch 38 Pc Promo-line Mixed Set	1	1290
			
2607017512	Bosch Professional 40-piece Bosch Blue X-Line titanium set	1	1377
			
2608522376	Bosch 2608522376 Extension Cord & 11 Piece Screwdriver Bit Set (6.35 mm 6.35 mm)	1	423
			
2608522377	Bosch PZ 2 Screwdriver Bit 6.35 mm (1/4 inch) External Hex Shank, 2608522377 (Pack of 11 Pcs)	1	448
			
2608522413	Pick & Click Extra Hard Screwdriver Bit Pack, 8-piece	1	208
			
2608522414	Pick & Click Extra Hard Screwdriver Bit Pack, 8-piece	1	208
			
2608522415	Pick & Click Extra Hard Screwdriver Bit Pack, 8-piece	1	213
			
2608522416	Pick & Click Extra Hard Screwdriver Bit Pack, 8-piece	1	235
			
2608522417	Pick & Click Extra Hard Screwdriver Bit Pack, 8-piece	1	387
			

SETS			
Part Number	Description	Unit Pack Qty	List Price(₹)
2608522418	Pick & Click Extra Hard Screwdriver Bit and Nutsetter Pack, 4-piece	1	437
			
2608522419	Pick & Click Extra Hard Screwdriver and HSS Impact Drill Bit Mixed Pack, 8-piece	1	846
			
2608522420	65 mm screwdriver bits and multi construction drill bits	1	888
			
2608619708	Cutting Disc	1	114
			
2608621253	Bosch 3pcs Abrasive Sponge Set	1	248
			
2608621254	S473 Best for Contour Combi Abrasive Sponge	1	248
			
2609256349	Bosch Professional Foam Abrasives - 2 pcs pad Medium- 69x97x26 mm	1	162
			
2609256350	Bosch Professional Foam Abrasives - 2 pcs pad fine- 69x97x26 mm	1	146
			
2609256351	Bosch contour sanding pad super fine 97x120x12 (2 pcs.)	1	100
			
2608608Y19	Bosch Professional Hand sanding sheet HSS-General Purpose- Pack of 10-230 x 280 mm Grit 40	1	200
			

SETS			
Part Number	Description	Unit Pack Qty	List Price(₹)
2608608Y20	Sanding Sheet BfWP,70x125mm,G60	1	215
2608608Y21	Sanding Sheet BfWP,70x125mm,G80	1	215
2608608Y22	Sanding Sheet BfWP,70x125mm,G100	1	215
2608608Y23	Sanding Sheet BfWP,70x125mm,G120	1	229
2608608Y24	Sanding Sheet BfWP,70x125mm,G150	1	229
2608608Y25	Sanding Sheet BfWP,70x125mm,G180	1	215
2608608Y26	Sanding Sheet BfWP,70x125mm,G220	1	215
2608608Y27	Sanding Sheet BfWP,70x125mm,G240	1	215
2608608Y28	Sanding Sheet BfWP,70x125mm,G320	1	215
2608608Y29	Sanding Sheet BfWP,70x125mm,G400	1	215

SETS			
Part Number	Description	Unit Pack Qty	List Price(₹)
2608594070	Bosch 2608594070 Professional 103-Pcs Accessory Set Versatile Drilling & Screwdriving Kit Titanium-Coated Metal Drill Bits Precision Hole Saws for Clean Cutouts Durable & Organized Carry Case	1	2,649
2607002835	Bosch Precision Screwdriver Bit Set 42-Piece Set	1	846
2607017692	Extra Hard Screwdriver Bit Set, 44+1 pcs	1	888



ACCESSORIES FOR GAC 250
NEW!

Part Number	Description	Unit Pack Qty	List Price(₹)
2602317081	Guide Rail	1	1,926
2604730027	Saw Chain	1	2,270
2604730028	Sprocket wheel	1	563
2608000808	Vacuum Adapter	1	280

COLLETS WITHOUT LOCKING NUT
 Suitable for GGS 27; GGS 27 C Professional; POF 500 A; POF 600 ACE

Part Number	Description	Unit Pack Qty	List Price(₹)
2608570008	Collet for 1210-3 mm	1	466
2608570047	Collet 6 mm	1	737
2608570049	Collet 8 mm	1	624
2608570048	Collet 1/4 inch	1	730

COLLETS WITH LOCKING NUT
 Suitable for GGS 7 C; GGS 27 L; GGS 27 LC; GGS 1212 Professional

Part Number	Description	Unit Pack Qty	List Price(₹)
2608570084	Collet 6 mm	1	1,139
2608570085	Collet 1/4 inch	1	1,154
2608570086	Collet 8 mm	1	1,376

COLLETS/NUTSET
 Suitable for GOF 130

Part Number	Description	Width Across Flat	Unit Pack Qty	List Price(₹)
2608570100	Collet 6 mm	19	1	1,290
2608570102	Collet 8 mm	19	1	1,326
2608570105	Collet 8 mm	-	1	1,478
2608570107	Collet 12 mm	-	1	1,492

HAND PROTECTORS FOR ANGLE GRINDERS
 in combination with auxiliary handle

Part Number	Description	Unit Pack Qty	List Price(₹)
1601329013	Hand Guard	1	403

AUXILIARY HANDLES FOR COMPACT BELT SANDERS AND MINI ANGLE GRINDERS

Part Number	Description	Unit Pack Qty	List Price(₹)
1602025024	Mini Grinder Side Handle	1	169

HANDLES FOR ROTARY HAMMERS

Part Number	Description	Unit Pack Qty	List Price(₹)
2602025076	Handle for GSH 10 C	1	2,800
2602025077	Auxiliary Handle	1	1,097

ACCESSORIES FOR ROTARY HAMMERS AND IMPACT DRILLS
 SDS plus quick-change chuck Suitable for GBH 4 DFE, GBH 4 DSC Professional, PBH 300 E

Part Number	Chuck Capacity	Mount Range	Unit Pack Qty	List Price(₹)
2608572059	SDS plus	SDS	1	4,084

KEYLESS CHUCKS
 Accessories for Drills

Part Number	Chuck Capacity mm	Mount Range	Impact-proof	Only for spindle lock	R/L rotation	Unit Pack Qty	List Price(₹)
-------------	-------------------	-------------	--------------	-----------------------	--------------	---------------	---------------

Upto 10 mm

2608572080	1.0-10.0	3/8"-24	-	-	•	1	2,043
2608572183	1.0-10.0	3/8"-24	•	•	•	1	2,042

Upto 16 mm

2608572062	2.0-13.0	1/2"-20	•	•	•	1	2,357
------------	----------	---------	---	---	---	---	-------

KEYED CHUCKS
 Accessories for Drills

Part Number	Chuck Capacity mm	Mount Range	Impact-proof	R/L rotation	Bench-mounted drill	Unit Pack Qty	List Price(₹)
-------------	-------------------	-------------	--------------	--------------	---------------------	---------------	---------------

Upto 10 mm

2608571010	0.5-6.5	3/8"-24	•	-	•	1	1,374
2608571078	1.0-10.0	3/8"-24	•	-	•	1	420
2608571080	1.0-10.0	1/2"-20	•	-	•	1	518

Upto 13 mm

2608571068	1.5-13.0	1/2"-20	•	•	-	1	1,345
2608571079	1.5-13.0	1/2"-20	•	-	•	1	535

Upto 16 mm

2608571056	1.5-13.0	1/2"-20	-	-	-	1	1,295
------------	----------	---------	---	---	---	---	-------

KEYED DRILL CHUCK

Part Number	Chuck Capacity mm	Mount Range	Unit Pack Qty	List Price(₹)
1608571048	1.5-13.0	1/2" - 20	1	1,077
1608571053	1.0-10.0	3/8" - 24	1	682
1608571054	1.0-10.0	1/2" - 20	1	799
1608571056	3.0-16.0	5/8" - 16	1	2,779
1608571061	1.0-10.0	1/2" - 20	1	1,233
1608571062	1.5-13.0	1/2" - 20	1	1,192

BLADES FOR SHEARS



Part Number	Description	Unit Pack Qty	List Price(₹)
3607010028	16 Gauge Shear Upper/Lower Blade Set	5	1,147
2607010025	14 Gauge Shear Upper/Lower Blade Set	5	1,600
3608635000	10 Gauge Shear Upper Replacement Blade	1	1,441
3608635002	10 Gauge Shear Lower Replacement Blade	1	979

FUNCTION ACCESSORIES PUNCH & DIES NIBBLER



Part Number	Description	Unit Pack Qty	List Price(₹)
2608639013	Curve Cutting Punch	1	1,486
2608639016	Straight Cutting Punch	1	2,945
2608639021	Special Die Corrugated	1	6,734
2608639022	Corrugated Punch	1	1,561
2608639025	Nibbling Punch for GNA 1.6L	1	7,221
2608639026	Lower Die	1	10,675
2608639900	Standard Die	1	8,507
2608639902	Punch & Die Set for Corrugated	1	5,161

FUNCTION ACCESSORIES PLANNING



Part Number	Description	Unit Pack Qty	List Price(₹)
2605411035	Dust Bag and Adapter	1	1,507

ACCESSORIES FOR HOT AIR, PAINTING AND STRIPPING NOZZLES FOR BOSCH HEAT GUNS



Part Number	Description	Unit Pack Qty	List Price(₹)
1609201647	Reduction Nozzles for Bosch Heat Guns with Electronic	1	935
1609201648	Reduction Nozzle - Hot Air Gun	1	756
1609201751	Angle Nozzle - Hot Air Gun	1	1,334
1609201795	Wide Hot Air Gun Nozzle 50mm	1	804
1609201796	Glass Protector Nozzle 50mm	1	800
1609201797	Reduction Nozzle - Hot Air Gun	1	727
1609201798	Welding Shoe for Heat Gun	1	1,351

ACCESSORIES FOR HOT AIR, PAINTING AND STRIPPING NOZZLES FOR BOSCH HEAT GUNS



Part Number	Description	Unit Pack Qty	List Price(₹)
1609201799	Slot Nozzle - Hot Air Gun	1	762
1609201800	Cutting Nozzle - Hot Air Gun	1	990
1609201801	Welding Nozzle- Hot Air Gun	1	777
1609201807	Plastic welding rod- Polyethylene (HDPE) black- 225mm length 4mm dia	1	1,131
1609201808	Plastic welding rod: Hard PVC, Transparent: 225 mm Length, 4mm dia	1	1,148
1609201809	PVC welding rod:	1	1,688
1609201810	Plastic welding rod: Polypropylene (PP) beige : 225 mm Length 4mm dia	1	1,067
1609201812	Plastic Tubing - Welding	1	814
1609390451	Surface nozzle with surface distribution of the hot air for drying, removing paint, thawing.	1	766
1609390452	Bosch Protection Nozzle - Hot Air Gun	1	762
1609390453	Reflector nozzle with frontal deflection for soldering, tinning and shrinking. comes in previous table	1	757

GENERAL HOSE



Part Number	Description	Unit Pack Qty	List Price(₹)
1609202230	Hose Ø 35 x 5,000 mm for belt sanders	1	8,163
F000600390	Hose	1	1,2766

TWO-HOLE SPANNER



Part Number	Description	Unit Pack Qty	List Price(₹)
1607950004	115mm Two-hole spanner, bent at right angles, Appropriate for cup wheels	1	473

MORSE TAPER			
Part Number	Description	Unit Pack Qty	List Price(₹)
1603115004	Morse taper MT 2 to 5/8" for use of chucks with capacity of up to 16 mm, 5/8"-16 UNF GBM 23-2, GBM 23-2 E, GBM 32-4, GBM 50-2 Professional	1	1,397



REPLACEMENT KEY			
Part Number	Description	Unit Pack Qty	List Price(₹)
1607950045	Replacement Key For Keyed Chucks	1	366



REDUCTION SLEEVE			
Part Number	Description	Unit Pack Qty	List Price(₹)
1608598028	Reduction Sleeve for drills enables use of morse taper MT 1 drills in an MT 2 machine	1	622



PIN - TYPE FACE			
Part Number	Description	Unit Pack Qty	List Price(₹)
1607950048	Two-hole spanner	1	172
1607950040	Pin spanner 100mm	1	352



FAST LOCKING FLANGE			
Part Number	Description	Unit Pack Qty	List Price(₹)
1603340031	Quick-Clamping Nut Thickness: 14 mm	1	2,062



RUBBER NOZZLE				
Part Number	Description	Diameter mm	Unit Pack Qty	List Price(₹)
1609201229	Rubber Nozzle for Bosch Extractors	35	1	608



LOCKING NUT			
Part Number	Description	Unit Pack Qty	List Price(₹)
1603340040	The Locking Nut clamps grinding discs with a 115-230 mm diameter	1	232



FLOOR NOZZLE				
Part Number	Description	Diameter mm	Unit Pack Qty	List Price(₹)
1609201230	Floor Nozzles for vacuum cleaning ground surfaces	35	1	913



BACKING FLANGE			
Part Number	Description	Unit Pack Qty	List Price(₹)
1605703099	Clamps Discs With 115-150 mm Diameter	1	277



Multi-Purpose Nozzle				
Part Number	Description	Diameter mm	Unit Pack Qty	List Price(₹)
1609390478	Multi-Purpose Nozzle is available with 2 or 3 inserts for wet and dry applications	35	1	2,684



AUXILIARY HANDLE			
Part Number	Description	Unit Pack Qty	List Price(₹)
1607000247	Strap-Shaped Handle	1	7,879



SMALL ROUND BRUSH NOZZLE				
Part Number	Description	Diameter mm	Unit Pack Qty	List Price(₹)
1609390481	Small Round Brush Nozzle is an external dust extraction device	35	1	1,156



CLAMPS DISCS			
Part Number	Description	Unit Pack Qty	List Price(₹)
1607950043	Two-Hole Spanner for Angle and Straight Grinders	1	121



HOSE FOR SUCTION BRACKET				
Part Number	Diameter mm	Length mm	Unit Pack Qty	List Price(₹)
1610793002	19	5	1	1,909



CHUCK ADAPTOR				
Part Number	Shank	For Drill Bits Shank	Unit Pack Qty	List Price(₹)
1617000132	SDS plus	1/2"-20 UNF	1	582



ADAPTOR FOR MAX M/CS				
Part Number	Description	Unit Pack Qty	List Price(₹)	
1618598159	17.72 x 15.75 x 9.84 inch	1	4,960	



REDUCTION RING				
Part Number	Description	Unit Pack Qty	List Price(₹)	
2600100222	30 x 25.4 x 1.5 mm	1	52	



DUST EXTRACTION				
Part Number	Description	Unit Pack Qty	List Price(₹)	
2600306007	Adaptor for Lightweight Hoses	1	801	



HOSE FOR DUST TRACTION				
Part Number	Diameter mm	Length (m)	Unit Pack Qty	List Price(₹)
2600793009	19	3	1	1,388



HANDLE				
Part Number	Description	Unit Pack Qty	List Price(₹)	
2602025075	Hand grip for Angle Grinders	1	255	



CLAMPING NUT				
Part Number	Description	Unit Pack Qty	List Price(₹)	
2603340018	Front Flange for GWS 6-100	1	396	



ROUND NUTS				
Part Number	Diameter mm	Unit Pack Qty	List Price(₹)	
2603345002	115/125	1	177	



CLOTH DUST BAG				
Part Number	Description	Unit Pack Qty	List Price(₹)	
2605411096	Cloth Dust Bag for GEX 150 AC	1	1,113	



DUST BOX				
Part Number	Description	Unit Pack Qty	List Price(₹)	
2605411147	Microfilter Dustbox	1	719	



PAPER FILTER BAG				
Part Number	Description	Unit Pack Qty	List Price(₹)	
2605411150	Replacement Bag	5	1,674	



PAPER FILTER BAG				
Part Number	Description	Unit Pack Qty	List Price(₹)	
2605411163	Dust Bags - Wood only	5	3,832	



FLEECE FILTER BAG				
Part Number	Description	Unit Pack Qty	List Price(₹)	
2605411229	Filter bag for GAS 15L	5	3,336	



GAS 400 VACUUM CLEANER NEW!				
Part Number	Description	Unit Pack Qty	List Price(₹)	
2608000890	Telescopic handle, for GAS 400 A & GAS 12-40 MA	1	5,228	



2608000797	Wide Floor Nozzle	1	831
2608000806	Suction Pipe (3 pcs)	1	713
2608001109	Dust Bag Holder, for GAS 400 A & GAS 12-40 MA	1	199
2608000585	GAS 35/55 Hose sleeve 22/35mm	1	2,520
2608000568	GAS 35/55 5m/22mm conductive hose including PT adaptor	1	10,859
2608000891	Fleece Bag (3 pcs)	1	-
2608000768	Crevice Nozzle	1	-

PROTECTIVE GUARDS				
				
Part Number	Description	Diameter mm	Unit Pack Qty	List Price(₹)

2605510101	Protective Guards without Cover for Grinding	125	1	612
------------	--	-----	---	-----

PROTECTIVE GUARDS WITHOUT COVER				
				
Part Number	Description	Diameter mm	Unit Pack Qty	List Price(₹)

2605510172	Protective Guard without cover is intended for general grinding and sanding work	125	1	875
------------	--	-----	---	-----

CODED GUARD				
				
Part Number	Description	Unit Pack Qty	List Price(₹)	

2605510155	100 mm Coded Guard For GWS 6100	1	1,036	
------------	---------------------------------	---	-------	--

CLAMPING FLANGE				
				
Part Number	Description	Diameter mm	Unit Pack Qty	List Price(₹)

2605703030	Backing Flange clamps all discs with 115-150 mm diameter	115-150	1	392
------------	--	---------	---	-----

DUST EXTRACTOR PIPE				
				
Part Number	Diameter mm	Length m	Unit Pack Qty	List Price(₹)

2607000162	35	0.50	2	1,020
------------	----	------	---	-------

CREVICE NOZZLE				
				
Part Number	Diameter mm	Unit Pack Qty	List Price(₹)	

2607000165	35	1	468	
------------	----	---	-----	--

COARSE DIRT NOZZLE				
				
Part Number	Diameter mm	Unit Pack Qty	List Price(₹)	

2607000170	35	1	1,049	
------------	----	---	-------	--

PARALLEL GUIDE			
			
Part Number	Diameter mm	Unit Pack Qty	List Price(₹)

2607001387	10.00	1	3,707
------------	-------	---	-------

DUST EXTRACTOR HOSE				
				
Part Number	Diameter mm	Length m	Unit Pack Qty	List Price(₹)

2607002149	35	3	1	2,130
------------	----	---	---	-------

DUST EXTRACTOR HOSE				
				
Part Number	Diameter mm	Length m	Unit Pack Qty	List Price(₹)

2607002150	35	5	1	1,982
------------	----	---	---	-------

TEXTILE FILTER			
			
Part Number	Description	Unit Pack Qty	List Price(₹)

2607432013	Textile Filter is a replacement filter for Bosch dust extractors	1	801
------------	--	---	-----

BELLOWS FILTER					
					
Part Number	Size cm ²	Diameter mm	Height mm	Unit Pack Qty	List Price(₹)

2607432024	3000	139	185	1	3,189
------------	------	-----	-----	---	-------

PAPER FILTER BAG			
			
Part Number	Description	Unit Pack Qty	List Price(₹)

2607432035	Paper Filter Bag for GAS 35	1	1,419
------------	-----------------------------	---	-------

PAPER FILTER BAG			
			
Part Number	Description	Unit Pack Qty	List Price(₹)

2607432036	Paper Filter Bag for GAS 55	5	1,777
------------	-----------------------------	---	-------

FLEECE FILTER BAG			
Part Number	Description	Unit Pack Qty	List Price(₹)
2607432037	Fleece filter bag GAS 35	5	2,852

FLEECE FILTER BAG			
Part Number	Description	Unit Pack Qty	List Price(₹)
2607432038	Fleece filter bag GAS 55	5	4,521

FILTER BAG FOR FLUIDS			
Part Number	Description	Unit Pack Qty	List Price(₹)
2607432039	Filter Bag for Fluids for GAS 35, White	5	4,910

DISPOSAL BAG			
Part Number	Description	Unit Pack Qty	List Price(₹)
2607432043	Disposal Bag for GAS 35/55, Black	1	3,274

BASE PLATE			
Part Number	Description	Unit Pack Qty	List Price(₹)
2608000908	Footplate for Foam Rubber Cutters	1	8,226

FIXING-SET FOR CONCRETE			
Part Number	Diameter mm	Unit Pack Qty	List Price(₹)
2608002000	16	1	14,691

SDS PLUS ADAPTER			
Part Number	Description	Unit Pack Qty	List Price(₹)
2608598045	SDS-PLUS To 1/2 inch Square	1	1,146

PARALLEL GUIDE WITH CIRCLE CUTTER (JIGSAW)				
Part Number	Height mm	Depth mm	Unit Pack Qty	List Price(₹)
2608040289	440	30	1	471

BLADE GUIDE FOR FOAM RUBBER			
Part Number	Size mm	Unit Pack Qty	List Price(₹)
2608135020	130	1	3,062
2608135021	200	1	3,663
2608135022	300	1	4,633

COLLET CHUCK			
Part Number	Description	Unit Pack Qty	List Price(₹)
2608570125	10x24 mm	1	1,442

KEYLESS CHUCK			
Part Number	Description	Unit Pack Qty	List Price(₹)
2608572212	Keyless Chuck for GBH2-26 DFR	1	4,238

QUICK CHANGE CHUCK			
Part Number	Description	Unit Pack Qty	List Price(₹)
2608572213	Quick Change Chuck for GBH 2-26 DFR	1	2,828

KEYLESS CHUCK & SDS PLUS ADAPTOR			
Part Number	Size mm	Unit Pack Qty	List Price(₹)
2608572227	1.5 - 13 mm	1	2,212

CORE EXTENSION			
Part Number	Description	Unit Pack Qty	List Price(₹)
2608598045	1 1/4 inchx300 mm Extension	1	9,408

STIRRING BASKETS

Mixing effect from bottom upwards
M14 outer thread



Part Number	Diameter Basket mm	Total Length mm	Mixing Qty from kg	Mixing Qty to kg	Unit Pack Qty	List Price(₹)
3609201038	135	590	25	40	1	4,241

MIXER ATTACHMENT

WAF 13 mm, chuck 16 mm
Suitable for GRW 9 Professional



Part Number	Diameter Basket mm	Total Length mm	Mixing Qty from kg	Mixing Qty to kg	Unit Pack Qty	List Price(₹)
2607990022	135	590	25	40	1	5,501

STIRRER BASKET

120 mm



Part Number	Description	Dia meter mm	Length mm	Inter face	List Price(₹)
2608000842	Stirrer Basket 120 mm	120	600	M14 (SW 22)	1,060

CENTERING DEVICE



Part Number	Description	Unit Pack Qty	List Price(₹)
2609256C95	Centering Aid for Hole Saw and Drill	1	1,775

TORQUE ATTACHMEN



Part Number	Description	Unit Pack Qty	List Price(₹)
2609256968	Torque Attachment for Ixo 3 & 4	1	1,022



Discontinued Part Numbers Until stocks last

Part Number	Material Description	Segment	Unit Pack Qty	List Price(₹)
2608690132* New! 2608690577	Chisels	Pointed Chisels SDS-Plus, 250 mm, Set 10	1	6,104
1618600210* New! 2608690569	Chisels	SDS-Max, Flat Chisel, 280 mmx25 mm	1	882
2608608V34	Coated Abrasives	Set of Sanding Papers C460 - 150, 6 hole - 40	1	22
2608607322	Coated Abrasives	Flap Disc BfM, 115 mm, G40, 1x	1	143
2608606714	Coated Abrasives	Flap Disc BfM, 100 mm, G60, 1x	1	457
2608603699	Coated Abrasives	Flap Disc X435 - 100 mm - 40P	1	100
2608603431	Coated Abrasives	125 mm Flap Disc, 36 Grit, Pack of 10	1	81
2608603353	Coated Abrasives	180 mm X432 Flap Disc, Grit 40, Standard for Metal	1	378
2608603352	Coated Abrasives	125 mm X432 Flap Disc, Grit 120, Standard for Metal	1	97
2609256C99	Diamond Discs/Diamond Core Bits	Diamond Holesaw - 10mm	1	401
2609256C96	Diamond Discs/Diamond Core Bits	Diamond Holesaw - 5mm	1	1,158
2609256C88	Diamond Discs/Diamond Core Bits	Diamond Holesaw - 45mm	1	1,137
2609256C87	Diamond Discs/Diamond Core Bits	Diamond Holesaw - 35mm	1	937
2609256C86	Diamond Discs/Diamond Core Bits	Diamond Holesaw - 27mm	1	711
2609256C85	Diamond Discs/Diamond Core Bits	Diamond Holesaw - 22mm	1	607
2609256C84	Diamond Discs/Diamond Core Bits	Diamond Holesaw - 18mm	1	517
2608619961	Diamond Discs/Diamond Core Bits	Diamond Cup Wheel Grinding wheel 3inch turbo continuous	1	247
2608619962	Diamond Discs/Diamond Core Bits	Diamond Cup Wheel Grinding wheel 3inch segmented	1	247
2608619963	Diamond Discs/Diamond Core Bits	Diamond Cup Wheel Grinding wheel 4inch turbo continuous	1	464
2608619962	Diamond Discs/Diamond Core Bits	Diamond Cup Wheel Grinding wheel 3inch segmented	1	464
2608603611* New! 2608603615	Diamond Discs/Diamond Core Bits	Diamond Cutting Blade Expert for Tile	1	235

*New part number prices will be revised post clearance of old stock.

Discontinued Part Numbers Until stocks last

Segment	Material	Material Description	List Price ₹
Chisels	2608834104	Flat Chisel SAE - 4140	518
Chisels	2608690132	Pointed Chisels SDS-Plus, 250 mm, Set 10	6,104
Chisels	2608690062	400 mm SDS-Max, RTEC Chisel, 10 pcs pack	8,583
Chisels	1618600210	SDS-Max, Flat Chisel, 280 mmx25 mm	882
Circular Saw Blades	2608643061	Circular Saw Blade - Blue color - Expert - 305 mmx25.4 mm borex80 Teeth	6,640
Circular Saw Blades	2608643060	Circular Saw Blade - Blue color - Expert - 305 mmx25.4 mm borex60 Teeth	5,829
Circular Saw Blades	2608642191	Circular Saw Blade Optiline for Wood 125 mm diax20 mm borex40 Teeth	294
Circular Saw Blades	2608640914	Circular Saw Blade Optiline for Wood 305 mm diax25.4 mm bore x60 Teeth	1,410
Circular Saw Blades	2608640911	Circular Saw Blade Optiline for Wood 254 mm diax30 mm borex120 Teeth	1,486
Coated Abrasives	2608608V34	Set of Sanding Papers C460 - 150, 6 hole - 40	22
Coated Abrasives	2608621452	150 mm C460 Velcro Sanding Sheets, Grit 500, Pack of 100	25
Coated Abrasives	2608621450	150 mm C460 Velcro Sanding Sheets, Grit 280, Pack of 100	25
Coated Abrasives	2608621446	150 mm C460 Velcro Sanding Sheets, Grit 150, Pack of 100	25
Coated Abrasives	2608621444	150 mm C460 Velcro Sanding Sheets, Grit 100, Pack of 50	25
Coated Abrasives	2608601308	125 mm C460 Velcro Sanding Sheets, Grit 500, Pack of 50	17
Coated Abrasives	2608601300	125 mm C460 Velcro Sanding Sheets, Grit 120, Pack of 50	15
Coated Abrasives	2608601294	150 mm C460 Velcro Sanding Sheets, Grit 500, Pack of 50	18
Coated Abrasives	2608601285	150 mm C460 Velcro Sanding Sheets, Grit 100, Pack of 50	19
Coated Abrasives	2608619003	125 mm, Fibre Sanding Disc, Standard for Metal, Grit 100, Pack of 25	24
Coated Abrasives	2608619001	125 mm, Fibre Sanding Disc, Standard for Metal, Grit 40, Pack of 25	24
Coated Abrasives	2608608130	180 mm Fibre Disc, Prof for Metal, G24	2,077
Coated Abrasives	2608608125	Fibre Sanding Disc, Pack of 25	789
Coated Abrasives	2608608124	Fibre Sanding Disc Metal P24 Ø125	1,155
Coated Abrasives	2608608114	100 mm Fibre Disc, Prof for Metal, G80	711
Coated Abrasives	2608608104	180 mm, 100 Grit, Pack of 25	2,190
Coated Abrasives	2608607935	Sanding Sheet BfWP, 115 x 230 mm, G120	4,399
Coated Abrasives	2608607933	Sanding Sheet BfWP, 115 x 230 mm, G80	3,483
Coated Abrasives	2608607932	Sanding Sheet BfWP, 115 x 230 mm, G60	4,544
Coated Abrasives	2608607931	Sanding Sheet BfWP, 115 x 230 mm, G40	3,642
Coated Abrasives	2608607366	Flap Disc EfM, 125 mm, G60, 1x	181
Coated Abrasives	2608607365	Flap Disc EfM, 125 mm, G40, 1x	215
Coated Abrasives	2608607326	Flap Disc BfM, 125 mm, G40, 1x	157
Coated Abrasives	2608607322	Flap Disc BfM, 115 mm, G40, 1x	143
Coated Abrasives	2608606924	Flap Disc BfM, 125mm, G80, 1x	391
Coated Abrasives	2608606714	Flap Disc BfM, 100 mm, G60, 1x	457

Discontinued Part Numbers Until stocks last

Segment	Material	Material Description	List Price ₹
Coated Abrasives	2608607250	Fibre Sanding Disc EfM, 125 mm, G36, 1x	31
Coated Abrasives	2608606921	Fibre Sanding Disc EfM, 100 mm, G120, 1x	26
Coated Abrasives	2608606920	Fibre Sanding Disc EfM, 100 mm, G100, 1x	19
Coated Abrasives	2608606919	Fibre Sanding Disc EfM, 100 mm, G80, 1x	19
Coated Abrasives	2608605487	Fibre Sanding Disc EfM, 180mm, G80, 1x	48
Coated Abrasives	2608605478	Fibre Sanding Disc EfM, 125 mm, G100, 1x	23
Coated Abrasives	2608605476	Fibre Sanding Disc EfM, 125 mm, G60, 1x	24
Coated Abrasives	2608603699	Flap Disc X435 - 100 mm - 40P	100
Coated Abrasives	2608603357	X532 Flap Disc, 100 mm, 40 Grit	129
Coated Abrasives	2608603431	125 mm Flap Disc, 36 Grit, Pack of 10	81
Coated Abrasives	2608603353	180 mm X432 Flap Disc, Grit 40, Standard for Metal	378
Coated Abrasives	2608603352	125 mm X432 Flap Disc, Grit 120, Standard for Metal	97
Coated Abrasives	2608603345	115 mm Flap Disc, Grit 40, Standard for Metal	117
Coated Abrasives	2608601670	X433 Flap Disc, 100 mm, 16 mm Bore, 120 Grit, Pack of 10	40
Coated Abrasives	2608601667	X433 Flap Disc, 100 mm, 16mm Bore, 36 Grit, Pack of 10	41
Diamond Discs/Diamond Core Bits	2609256C99	Diamond Holesaw - 10mm	401
Diamond Discs/Diamond Core Bits	2609256C96	Diamond Holesaw - 5mm	1,158
Diamond Discs/Diamond Core Bits	2609256C88	Diamond Holesaw - 45mm	1,137
Diamond Discs/Diamond Core Bits	2609256C87	Diamond Holesaw - 35mm	937
Diamond Discs/Diamond Core Bits	2609256C86	Diamond Holesaw - 27mm	711
Diamond Discs/Diamond Core Bits	2609256C85	Diamond Holesaw - 22mm	607
Diamond Discs/Diamond Core Bits	2609256C84	Diamond Holesaw - 18mm	517
Diamond Discs/Diamond Core Bits	2607019471	Diamond Cutting Disc for Tiles, Diameter 110 mm, Metallic, Silver	350
Diamond Discs/Diamond Core Bits	2608603679	200 mm Expert for Universal Diamond Cutting Disc, 25.4 mm/22.23 mm	1,409
Diamond Discs/Diamond Core Bits	2608603611	Diamond Cutting Blade Expert for Tile	235
Diamond Discs/Diamond Core Bits	2608603332	Diamond Cutting, 230 mm, 25.4 mm Bore, 2.4 mm Cutting Width, 1 pc pack	1,374
Diamond Discs/Diamond Core Bits	2608603331	Diamond Cutting, 180 mm, 25.4 mm Bore, 2.2 mm Cutting Width, 1 pc pack	787
Diamond Discs/Diamond Core Bits	2608603329	Diamond Cutting, 125 mm, 22.23 mm Bore, 2.0 mm Cutting Width, 1 pc pack	428
Diamond Discs/Diamond Core Bits	2608603306	Diamond Cutting Blade, 105 mm, 2.5 mm Cutting Width, 8 mm Segment Height	319
Diamond Discs/Diamond Core Bits	2608602626	Diamond Cutting Disc, Standard for Asphalt 400 mm dia X 20/25.4 mm Bore	9,134
Diamond Discs/Diamond Core Bits	2608602601	Diamond Cutting Disc, Pro for Stone, 230 mm dia X 22.23 mm Bore	1,454

Discontinued Part Numbers Until stocks last

Segment	Material	Material Description	List Price ₹
Diamond Discs/Diamond Core Bits	2608602193	Diamond Cutting Disc, Pro for Universal, 150 mm dia X 22.23 mm Bore	807
Diamond Discs/Diamond Core Bits	2608601573	Diamond Cup Wheel, Standard for Concrete, 125 mm with 22.23 mm Bore	2,386
Diamond Discs/Diamond Core Bits	2608601370	Diamond Wet Core Cutters 1 1/4" UNC Best for Concrete, 127 mm dia, 450 mm Working Length, 11 Segments, 11.5 mm Segment Height	20,499
Diamond Discs/Diamond Core Bits	2608601366	Diamond Wet Core Cutters 1 1/4" UNC Best for Concrete, 127 mm dia, 450 mm Working Length, 11 Segments, 11.5 mm Segment Height	1,1076
Diamond Discs/Diamond Core Bits	2608601360	Diamond Wet Core Cutters 1 1/4" UNC Best for Concrete, 127 mm dia, 450 mm Working Length, 11 Segments, 11.5 mm Segment Height	5,272
Diamond Discs/Diamond Core Bits	2608580577	Diamond Wet Core Cutters, 202 mm dia, 450 mm Working Length,	21,127
Diamond Discs/Diamond Core Bits	2608580564	Diamond Wet Core Cutters, 92 mm dia, 450 mm Working Length	12,366
Diamond Discs/Diamond Core Bits	2608580563	Diamond Wet Core Cutters, 82 mm dia, 450 mm Working Length	10,082
Diamond Discs/Diamond Core Bits	2608580555	Diamond Wet Core Cutters, 40 mm dia, 300 mm working length	8,830
Diamond Discs/Diamond Core Bits	2608580554	Diamond Wet Core Cutters, 37 mm dia, 300 mm Working Length	9,948
Diamond Discs/Diamond Core Bits	2608580551	Diamond Wet Core Cutters, 30 mm dia, 300 mm Working Length	8,069
Diamond Discs/Diamond Core Bits	2608550512	Diamond Wet Core Cutters, 122 mm dia, 450 mm Working Length	23,081
Hammer Drilling Plus	2608830963	SDS-Plus Hammer Drill Bit Plus-3 D14 x 160	3,967
Hammer Drilling Plus	2608830952	SDS-Plus Hammer Drill Bit Plus-3 D7 x 210	2,428
Hammer Drilling Plus	2608830949	SDS-Plus Hammer Drill Bit Plus-3 D6.5 x 210	2,302
Hammer Drilling Plus	2608830947	SDS-Plus Hammer Drill Bit Plus-3 D6 x 210	2,142
Hammer Drilling Plus	2608585606	Rotary Hammer Bit 12 x 300 x 360	1,946
Holesaws	2608584844	Power-change adapter with 8 mm Hex Shank. For Holesaw diameter of 14-210 mm. Without pilot drill bit.	1,213
Holesaws	2608580506	Progressor for Wood and Metal Holesaw, 98 mm	1,400
Holesaws	2608580492	Progressor for Wood and Metal Holesaw, 60 mm	773
Holesaws	2609390035	"Accessories for Holesaws with standard adapter, SDS-Plus adapter with 1/2" - 20UNF thread and HSS-G pilot drill bit (2 608 596 295) for diameter 14 mm, 9/16" - diameter 30 mm, 1 3/16"	524
Impact Drill Bits/Masonry	2609255467	Glass Drill Bit 6 mm	182
Impact Drill Bits/Masonry	2609255466	Glass Drill Bit 5 mm	175
Impact Drill Bits/Masonry	1609200228	Drill Bit CYL-1, 5 pcs set, 4, 5, 6, 8, 10	421
Jig Saw Blades	2608633A31	T114DP, HCS Precision for Wood, 3 Pack	283
Jig Saw Blades	2609256748	Saw Blade Set	121

Discontinued Part Numbers Until stocks last

Segment	Material	Material Description	List Price ₹
Jig Saw Blades	2608636703	T121BF, Speed for Metal, BiM, 25 pcs pack	1,973
Jig Saw Blades	2608636420	Saw Blade Set, T118EFS, Basic for Inox (Stainless steel), 5 pcs pack	400
Jig Saw Blades	2608630568	U144D, U Shank, HCS, Speed for Wood, 3 Pack	145
Metal Grinding	9617085464	Cutting Disc	85
Metal Grinding	2608619343	100 mm/4" Cutting Disc, 16 mm Bore, 1.2 mm thick, A 60 N BF	23
Metal Grinding	2608619284	Cutting - off Wheel, X-Lock Carbide Multi Wheel, Ø125 mm	567
Metal Grinding	2608600660	7 inch, Rough Grinding Disc	135
Metal Grinding	1608600234	Conical Cup Wheels – Metal, Cast Iron, 90mm min dia, 110 mm max dia, 55 mm height, 60 Grit, pack of 1	860
Metal Grinding	1608600233	Conical Cup Wheels – Metal, Cast Iron, 90mm min dia, 110 mm max dia, 55 mm height, 36 Grit, pack of 1	867
Metal Grinding	1608600231	Conical Cup Wheels – Metal, Cast Iron, 90 mm min dia, 110 mm max dia, 55 mm height, 16 Grit, pack of 1	813
Planer Knives	2608635229	Planing Knife	1,093
Planer Knives	1607000182	Set of Knives 2P-82, 4 x 1, 1 x 5, 5	1,425
Reciprocating Saw Blades	2608661638	Bosch Hcs Plunge Cutting Saw Blade Wood	666
Reciprocating Saw Blades	2607017199	Handle Hand Saw with 2 RCB	1,393
Routing	2607019469	Router Bit Green Set, 15 Pcs Set x 8 mm shank	4,256
Routing	2607019466	Router Bit Green Set, 12 Pcs Set x 8 mm shank	2,461
Routing	2607019464	Router Bit Green Set, 6 Pcs Set x 6 mm shank	1,742
Screwdriving Bits	2607017377	Hit and Run, 46 Pcs set	921
Screwdriving Bits	2607011432	Hit and Run, 38 Pcs Set	673
Screwdriving Bits	1608556033	Hexagon Socket Wrench, 36 mm, length - 55 mm	836
Screwdriving Sets	2607001467	Extra Hard for Slotted Screws 1.2 x 6.5 (25 mm length) x Pack of 25	1,487
Screwdriving Sets	2607000218	Locking Clip 19 - 80 mm	3,431
Starlock	2608661757	AVZ 70 RT4 Carbide Grout + Abrasive 1 Pack	3,102
Starlock	2608661648	AVZ 78 RT2 Carbide Grout + Abrasive 1 Pack	3,067
Starlock	2608661639	AIZ 10EC HCS Plunge Cutting Wood 10 x 30 mm	598
Starlock	2608000493	AVZ 93 G Delta Sanding Plate 1 Pack	584
System AC + Others	2609200306	Spare Bulb for PLI/GLI 12V	194
System AC + Others	2608612027	Polishing Accessories for GPO 14 CE Professional, Rubber Backing Pad 150 mm, 1x	1,517
System AC + Others	2608601077	Regular Backing Pads for Fibre Sanding Discs, 125 mm, Pack of 1	1,081
System AC + Others	2608570082	Collect 3 mm Locking Nut for Straight Grinders	1,151
System AC + Others	2607990073	Protective Goggles GO 2C	1,023
System AC + Others	2607432034	Pes Flat Pleated Filter	4,653
System AC + Others	2607018299	NA 19 Needle Descaler	49,913
System AC + Others	2607001409	Universal Cutting Oil	794
System AC + Others	2605730036	New Brushes for 2605510107	1,090

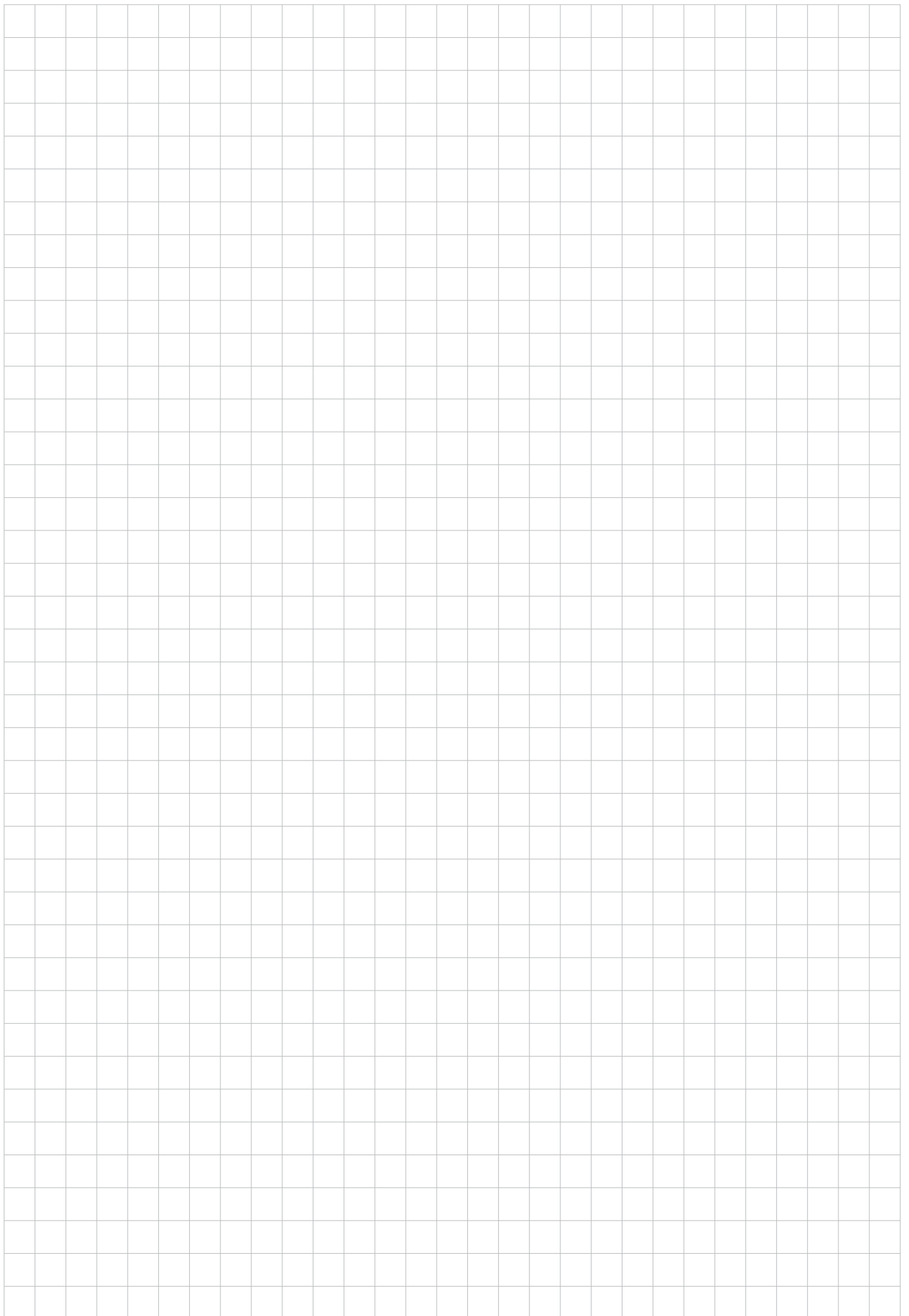

Bosch Limited, Power Tools Division
Post Box No. 3000, Hosur Road, Adugodi, Bangalore
Karnataka- 560030

 www.facebook.com/BoschPTIndia



Customer Contact Center
1800 425 8665

Email: bosch.accessories@in.bosch.com
www.bosch-pt.co.in